

Mechanical Fittings & Valves

Product List and Technical Catalogue
2012

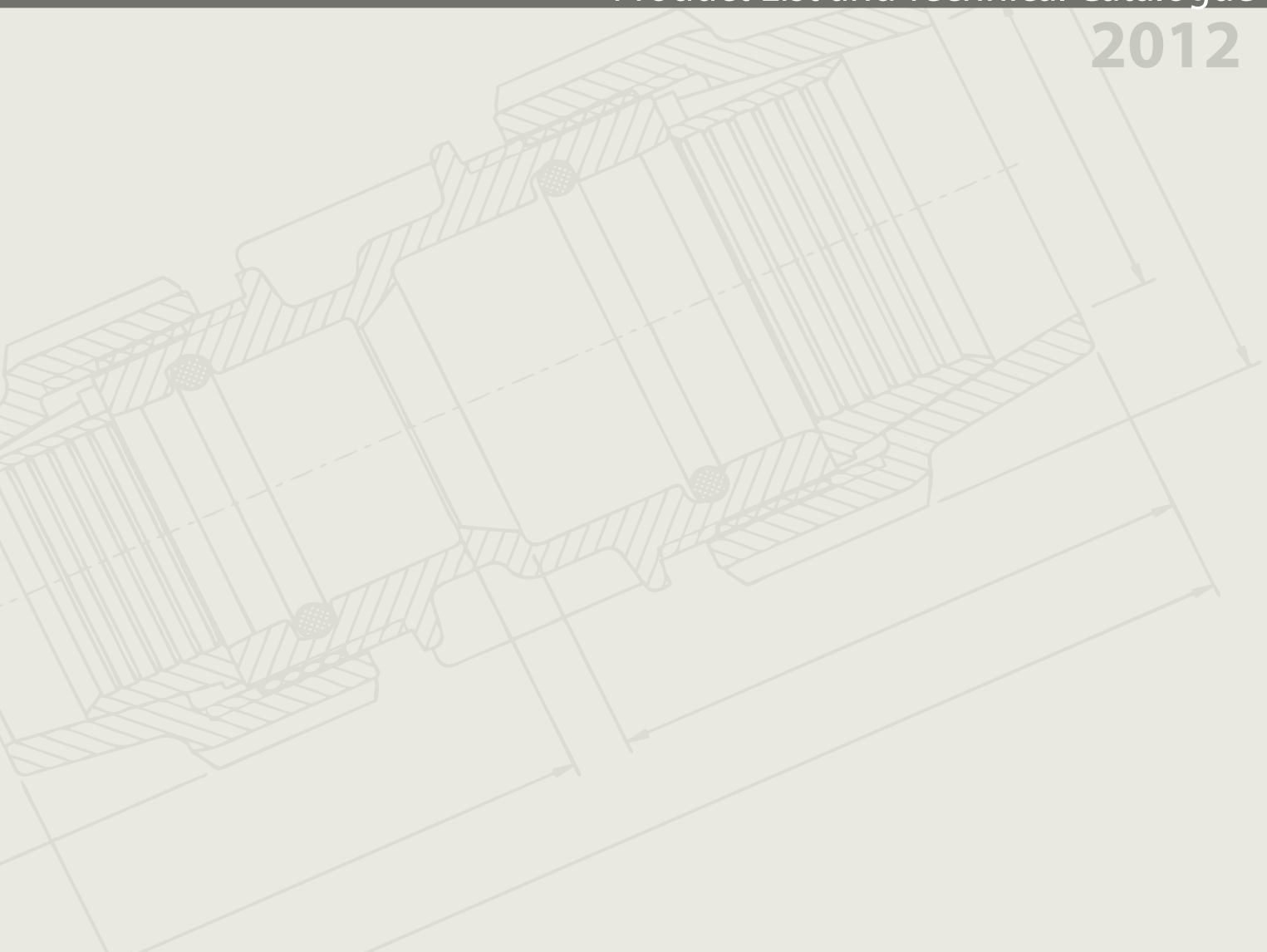



Plasson's innovative products revolutionized the way of connecting polyethylene pipes in the 1960's. We started with fittings for agricultural irrigation and later developed products for urban water distribution.

Nowadays, water delivery systems in some of the world's great cities, owe their excellence to Plasson's innovative research and development.

We have achieved superior designs and products, the widest range of fittings and adaptors and a genuine commitment to quality, delivery and service.

Plasson continues to strive for the future environment. By buying Plasson products, you help us to invest in our vision of a world where clean, pure water will be everyone's birthright.

Les produits innovateurs de Plasson ont révolutionné le mode de connection des tuyaux en polyéthylène dans les années 60. Nous avons débuté avec des raccords pour l'irrigation dans l'agriculture et, par la suite, avons développé des produits pour la distribution de l'eau en milieu urbain.

Aujourd'hui, les systèmes d'écoulement d'eau dans plusieurs grandes villes du monde doivent leur performance aux résultats obtenus par la recherche et le développement des produits de Plasson.

Les efforts que nous avons investis nous ont placé à un niveau d'excellence aussi bien dans le design et les matériaux, que par la vaste gamme de raccords et d'adaptateurs que nous offrons, tout en observant strictement notre engagement en matière de qualité, de conditions de livraison et de services.

Notre regard est constamment orienté vers l'avenir de l'environnement. En choisissant les produits de Plasson, vous contribuez à notre vision d'un monde où chacun aura droit, à sa naissance, à une eau pure et saine, gérée avec économie.

En los años sesenta Plasson revolucionó la forma de conectar tubos de polietileno. En el principio fueron conectores para uso agrícola a partir de los cuales se desarrollaron, más tarde, productos para distribución de agua en sistemas municipales.

Hoy en día, algunas de las más grandes ciudades del mundo, deben la excelencia de sus sistemas de suministro de aguas a la investigación y desarrollo de Plasson.

Plasson no ha ahorrado esfuerzos para desarrollar, mediante excelente diseño, empleando los mejores materiales y con un total compromiso de calidad y servicio, la más amplia línea de conectores y adaptadores.

Nuestro compromiso con el medio ambiente es permanente. Comprando productos Plasson, usted está ayudándonos a seguir invirtiendo en nuestra visión de un mundo donde agua limpia y pura es un derecho natural de todos.

Compression Fittings for PE pipe	10 - 32
Conversion & Adaptor Sets from PE to Copper / UPVC / PP / Lead / Galvanised Pipe	33 - 37
Pipe Conversion Chart	38
Accessories for Compression Fittings	39 - 44
Fittings for 160mm PE Pipe	45 - 47
Saddles	48 - 52
BSP Threaded Fittings	53 - 57
Valves	58 - 66
Technical Specifications	68 - 73
Installation Instructions for Compression Fittings	74 - 75
Installation Instructions for Pipe Adaptors Conversion Sets	76 - 78
Installation Instructions for Plass4 and Copper Pipe Adaptor (Universal Adaptor)	79

Raccords de compression pour tube PE	10 - 32
Sets de conversion et d'adaptateurs pour tuyaux PE / UPVC / PP / Plomb / Inox	33 - 37
Tableau de conversion des tuyaux	38
Accessoires pour raccords de compression	39 - 44
Raccords pour tube PE de 160mm	45 - 47
Colliers	48 - 52
BSP raccords filetés	53 - 57
Robinets	58 - 66
Spécifications techniques	68 - 73
Instructions de montage pour les raccords de compression	74 - 75
Instructions de montage pour sets de conversion adaptateurs de tubes	76 - 78
Instructions de montage pour raccords Plass4 et adaptateurs pour tube en cuivre (adaptateur universel)	79

Accesorios de presión para tubos de PE	10 - 32
Juegos de conversión y adaptadores de PE a Cobre / PVC rígido / PP / Plomo / Tubos galvanizados	33 - 37
Gráfico de conversiones para tuberías	38
Recambios y Accesorios	39 - 44
Accesorios para tuberías de PE 160mm	45 - 47
Collarines	48 - 52
Accesorios roscados (BSP)	53 - 57
Válvulas	58 - 66
Detalles técnicos	68 - 73
Instrucciones de montaje (para accesorios de presión)	74 - 75
Instrucciones de montaje (para adaptadores de tubos) Juegos de conversión	76 - 78
Instrucciones de montaje de Plass4 & tubo de cobre y adaptador Universal	79

Compression Fittings

07010

Coupling
Manchon
Enlace recto



Page 10

07610

Repair Coupling
Manchon de réparation
Enlace recto de réparation



Page 11

07110

Reducing Coupling
Manchon de réduction
Enlace Recto Reductor



Page 12

07020

Male Adaptor
Raccord mâle
Enlace mixto rosca macho



Page 13

07720

Male Integral Brass Thread
Raccord de transition mâle en laiton fileté
Enlace mixto rosca macho de laiton



Page 14

07030

Female Adaptor
Raccord femelle
Enlace mixto rosca hembra



Page 14-15

0703GO

Female Adaptor G
Raccord femelle parallèle
Enlace mixto rosca hembra G



Page 15

07320

Shouldered Adaptor
Raccord à emboîture
Adaptador minero



Page 16

07120

End Plug
Bouchon mâle
Tapón final



Page 17

07050

90° Elbow
Coude à 90°
Codo de 90°



Page 18

07510

90° Reducing Elbow
Coude de réduction à 90°
Codo de 90° reductor



Page 18

07850

90° Elbow with Threaded Male Offtake
Coude à 90° avec dérivation filetée mâle
Codo de 90° compresión rosca macho



Page 19

07770

90° Elbow with Male Integral Brass
Coude de transition à 90° avec filetage mâle en laiton
Codo de 90° con macho integral de latón



Page 20

07150

90° Elbow with Threaded Female Offtake
Coude à 90° avec dérivation filetée femelle
Codo de 90° compresión rosca hembra



Page 20-21

07060

45° Elbow
Coude à 45°
Codo de 45°



Page 21

07450

45° Elbow with Threaded Male Offtake
Coude à 45° avec dérivation filetée mâle
Codo de 45° compresión rosca macho



Page 22

07350

90° Elbow Adaptor
Adaptateur coudé à 90°
Codo espiga



Page 22

07750

Wall Plate Elbow
Coude applique murale
Codo de aplicación mural



Page 22

07040

90° Tee
Té à 90°
Te de 90°



Page 23

0704PO

90° Slip Tee
Té à 90° de réparation
Te de 90° de reparación



Page 23

07740

90° Enlarging Tee
Té agrandisseur à 90°
Te de 90° alargado



Page 24

07340

90° Reducing Tee
Té de réduction à 90°
Te de 90° reductor



Page 24

07840

90° Tee with Threaded Male Offtake
Té à 90° avec dérivation fileté mâle
Te de 90° compresión rosca macho



Page 25

0714S0

90° Reducing Tee with Threaded Female Offtake
Té de réduction à 90° avec dérivation fileté femelle
Te de 90° reducción compresión rosca hembra



Page 25

07140 / 0714P0

90° Tee with Threaded Female Offtake/Slip Tee
Té à 90° avec dérivation fileté femelle/Té à réparation
Te de 90° compresión rosca hembra/Te de reparación



Page 26-27

07810

Coupling with Riser
Té à 90° avec dérivation fileté longue
Enlace recto con derivación rosca macho



Page 27

07640

45° Tee
Té à 45°
Te de 45°



Page 28

07220

Compression Flange Adaptor (with metal flange)
Raccord à bride (avec bride de métal)
Adaptador compresión-brida (con brida de metal)



Page 28-29

072306

Flange Adaptor (with metal flange)
Adaptateur à bride (avec bride de métal)
Adaptador espiga-brida (con brida de metal)



Page 29

07006

Metal Flange
Bride de métal
Brida de metal



Page 30

07250

Threaded Adaptor
Adaptateur fileté
Adaptador compresión rosca macho



Page 30

07270

Brass Threaded Adaptor
Adaptateur en laiton fileté
Adaptador rosca de latón



Page 31

070170

Plass4 (Universal) Coupling
Plass4 - (manchon universel)
Plass4 Enlace universal



Page 31

070570

Plass4 (Universal) Elbow
Plass4 - coude à 90° (universel)
Codo universal - Plass4



Page 32

07550

Y-fitting with Threaded Male Offtake
Raccord Y avec dérivation fileté mâle
Y compresión rosca macho



Page 32

07540

Cross with Threaded Female Offtake
Croix avec dérivation fileté femelle
Cruz compresión rosca hembra



Page 32

Conversion & Adaptor Sets

071209

Plug Adaptor
Bouchon universel
Tapón ciego



Page 33

07950

Pipe Liner for PE SDR 11 Pipe
Renfort pour tube PE SDR 11
Refuerzo de tubos



Page 33

07896

Adaptor for Copper and Imperial UPVC
Adaptateur pour tube en cuivre et UPVC impérial
Adaptador universal para tubos de cobre y UPVC impérial



Page 33

07930

Reducing Set
Set de réduction
Juego reductor



Page 34

07940

Modular Adaptor
Adaptateur module
Adaptador modular



Page 34

0701C0

Copper Pipe Adaptor
Adaptateur pour tube en cuivre
Adaptador tubo de cobre



Page 35

0711B0 / 0701B0

PB Pipe Adaptor
Adaptateur Pour Tube Plomb
Adaptor Para Tubo de Plomo



Page 35

07970

Grip Ring for UPVC and PP Pipe
Rondelle de retenue en inox pour tube UPVC et PP
Casquillo de apriete para tubos de UPVC y PP



Page 35

07438

Conversion Set for Copper Pipe
Set de conversion pour tube en cuivre
Juego adaptador para tubos de cobre



Page 36

077802

Conversion Set for Lead Pipe
Set de conversion pour tube en plomb
Juego adaptador para tubos de plomo



Page 37

078908

Converter Rubber Adaptor for Galvanised Pipe
Joint convertisseur adaptateur pour tube en acier galvanisé
Conversor Adaptador de goma para tubos de acero galvanizado



Page 37

078907

Conversion Set Adaptor for Galvanised Pipe
Set de conversion adaptateur pour tube en acier galvanisé
Juego conversor de compresion para tubos de acero galvanizado



Page 37

Accessories

07004

Nut
Ecroû de serrage
Racor



Page 39

07002

O - Ring / Seal
Joint torique
Junta tórica / sello



Page 40-41

07003

Split Ring
Bague de crampage
Casquillo de apriete



Page 42-43

07005

Insert
Insert (PP)
Inserto de PP



Page 44

07960

Chamfer Tool for PE Pipes
Outil à chanfreiner
Herramienta para biselar



Page 44

07990

Plasson Wrench
Clé Plasson
Llave Plasson



Page 44

160 mm

070106

Coupling / Repair Coupling
Manchon / Manchon de réparation
Enlace recto / Enlace recto de reparación



Page 45

070406

90° Tee
Té à 90°
Te de 90°



Page 45

070506

90° Elbow
Coude à 90°
Codo de 90°



Page 46

072206

Compression Flange Adaptor (with metal flange)
Raccord à bride (avec bride de métal)
Adaptador compresión-brida (con brida de metal)



Page 46

072306

Flange Adaptor (with metal flange)
Adaptateur à bride (avec bride de métal)
Adaptador brida-espiga (con brida de metal)



Page 46

073206

Shouldered Adaptor
Raccord à emboiture épaulée
Adaptador minero



Page 47

17006

Metal Flange
Bride de métal
Brida Metálica



Page 47

Threaded and Compression Outlet Saddles

16076/16086/16279/16079

Saddle Single Outlet
Collier de prise simple
Collarín simple



Page 48

16176/16186 /16179

Saddle Double Outlet
Collier de prise double
Collarín doble



Page 49

16005 / 16007

Plated Nut & Bolt for Saddles
Visse et écrou pour colliers en acier galvanisé
Tornillo y tuerca de acero niquelado para collarin



Page 50/52

16810

Compression Saddle
Collier à compression
Collarín simple de compresión



Page 50

Tapping Saddles & Valves

18680

Mechanical Tapping Valve
Prise de branchement mecanique avec robinet
Valvula Mecanica con salida rotatoria Tapper®



Page 51

16540 **Page 51**

Tapper® - for PVC & PE Pipes
Prise de branchement Tapper® pour tube PVC et PE
Collarin con salida rotatoria Tapper® para tubos de PVC y de PE



051107 **Page 56**

Threaded Reducing Socket
Manchon de réduction fileté
Manguito reductor rosca hembra - hembra



165400012 **Page 52**

Tapper® Brass Cutter for PE & PVC Pipe
Couteau pour tube PE et PVC
Cortatubo para tubos de PE y de PVC



051607 **Page 57**

Threaded Riser
Rallonge fileté
Espiga roscada



16532 **Page 52**

Saddle Seal for Tapper® (EPDM)
Joint pour Tapper® (EPDM)
Sello de collarín Tapper® (EPDM)



051707 **Page 57**

Threaded Plug
Bouchon fileté
Tapón rosca macho



BSP Threaded Fittings

050107 **Page 53**

Threaded Socket
Manchon fileté femelle
Manguito rosca hembra x hembra



Valves

03405 **Page 58**

Threaded Stoptap
Robinet à soupape droite
Válvula de línea rosca hembra



050207 **Page 53**

Threaded Reducing Bushing
Manchon de réduction fileté
Manguito reductor hembra x macho



03407 **Page 58**

Compression Stoptap
Robinet à soupape droite, embouts compression
Válvula de línea compresión



050407 **Page 54**

90° Threaded Tee
Té à 90° fileté femelle
Te de 90° rosca hembra



03048 **Page 59**

Angle Seat Valve Threaded x Compression
Robinet à soupape oblique, embouts filetés/compression
Válvula de asiento angular - compresión - rosca



050507 **Page 54**

90° Threaded Elbow
Coude à 90° fileté femelle
Codo de 90° rosca hembra



03047 **Page 59**

Angle Seat Valve (seal NBR), Threaded Inlet & Outlet
Robinet à soupape oblique (joint NBR), embouts filetés
Válvula de asiento angular (sello NBR), roscas macho



051507 **Page 55**

90° Threaded Elbow Male x Female
Coude à 90° fileté mâle x femelle
Codo roscado-macho x hembra



03049 **Page 60**

Angle Seat Valve (seal FPM), Threaded Inlet & Outlet
Robinet à soupape oblique (joint FPM), embouts filetés
Válvula de asiento angular (sello FPM), roscas macho



050605 **Page 55**

Threaded Reducing Nipple
Mamelon de réduction fileté
Machón doble reductor



03046 **Page 60**

Angle Seat Valve Compression Inlet & Outlet
Robinet à soupape oblique, embouts compression
Válvula de asiento angular compresión



050607 **Page 56**

Threaded Nipple
Mamelon double fileté
Machón doble



03067 **Page 61**

Check Valve (seal EPDM), Threaded Inlet & Outlet
Soupape de retenue (joint EPDM), embouts filetés
Válvula antirretorno (Juntas EPDM), roscas macho



050707 **Page 56**

Threaded Cap
Bouchon fileté
Tapón rosca hembra



03039 **Page 61**

Quick Coupling Valve
Clapet vanne démontable
Válvula de acople rápido



03139

Key for Quick Coupling Valve 3039
Branchement pour clapet vanne 3039
Conexión de acople rápido



Page 61

03226 / 03227

Check Valve Insert
Soupape de retenue
Valvula de control



Page 62

3589

BSPT Record for Water Meter
Adaptateur pour compteur d'eau D'EAU
Tubo y tuerca BSPT



Page 62

03510

Water Meter Manifold
Rail pour compteur à eau
Soporte para control de flujo de agua



Page 62

Quarter Turn Valves

03010

Male Threaded X Compression
Robinet un quart de tour male filete/compression
Rosca Macho-/Compresion



Page 63

03011

Female Threaded X Compression
Robinet un quart de tour femelle filetee / compression
Rosca Hembra-/ Compresion



Page 63

03012

Male Threaded X Female Threaded
Robinet un quart de tour male filete / femelle filetee
Rosca Macho-/Rosca Hembra



Page 64

03013

Flex Hose X Female Threaded
Robinet un quart de tour pour tuyau souple / femelle filetee
Mangera Flexible/Rosca Hembra



Page 64

03016

Barbed X Female Threaded
Robinet un quart de tour tranchante / femelle filetee
Afilado Roscado-Rosca Hembra



Page 65

03017

Compression X Compression
Robinet un quart de tour embouts compression
Compresion



Page 65

03019

Garden Hose Male Thread X Female Threaded
Robinet un quart de tour pour tuyau de jardin
male filetee/femelle filetee
Rosca Macho Mangera de Jardin/Rosca Hembra



Page 66

03020

Male Threaded X Barbed
Robinet un quart de tour male filete / tranchante
Rosca Macho-Afilado Roscado



Page 66



ISRAEL



POLAND



FRANCE



AUSTRIA



AUSTRIA



AUSTRALIA



ITALY



SWITZERLAND



NETHERLANDS



NETHERLANDS



GERMANY



GERMANY



RUSSIA



RUSSIA



THE BEST *NEVER REST*

A wide range of innovative products
which continues to grow

- Quality
- Efficiency
- Reliability



 **PLASSON**[®]

Global Presence - Local Commitment

Coupling

Manchon
Enlace recto

07010

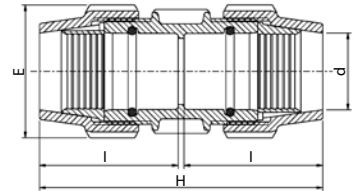

Size d x d	E	H	I	UB	UC	W
16 x 16	39	105	50	10	400	52
20 x 20	48	121	58	10	200	93
25 x 25	54	125	60	10	180	120
32 x 32	64	145	70	5	100	190
40 x 40	82	177	86	—	75	328
50 x 50	96	201	98	—	45	475
63 x 63	113	230	112	—	30	724
125 x 125	212	460	225	—	3	5266

87010

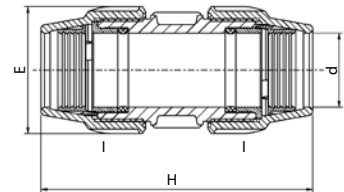

Size d x d	E	H	I	UB	UC	W
75 x 75	132	281	139	—	16	1251
90 x 90	152	323	160	—	7	1893
110 x 110	181	393	195	—	5	3303

Repair Coupling

Manchon de réparation
Enlace recto de reparación

07610

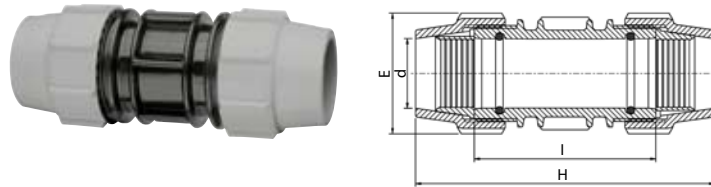

Size d x d	E	H	I	UB	UC	W
20 x 20	48	121	78	10	240	92
25 x 25	54	134	90	10	150	120
32 x 32	64	173	119	5	80	190
40 x 40	82	216	149	—	55	376
50 x 50	96	244	158	—	44	534
63 x 63	113	270	170	—	24	852
125 x 125	212	460	265	—	3	5250

87610

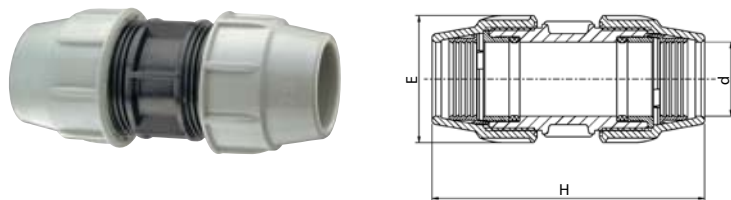

Size d x d	E	H	UB	UC	W
75 x 75	132	281	—	16	1251
90 x 90	152	323	—	9	1893
110 x 110	181	393	—	5	3303

Reducing Coupling

Manchon de réduction
Enlace Recto Reductor

07110

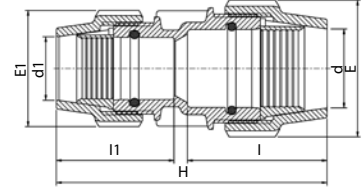

Size d x d1	E	E1	H	I	I1	UB	UC	W
20 x 16	48	39	111	56	50	10	300	74
25 x 16	54	39	120	55	50	10	220	88
25 x 20	54	48	119	60	54	10	200	104
32 x 20	64	48	135	62	53	5	150	142
32 x 25	64	54	131	66	57	5	120	154
40 x 25	82	54	155	81	60	—	90	230
40 x 32	82	64	155	81	66	—	90	255
50 x 25	96	54	176	93	59	—	70	300
50 x 32	96	64	173	97	61	—	70	341
50 x 40	96	82	182	92	82	—	60	400
63 x 25	113	54	187	108	50	—	50	461
63 x 32	113	64	199	110	64	—	45	486
63 x 40	113	82	209	110	82	—	40	546
63 x 50	113	96	215	110	95	—	36	587

87110

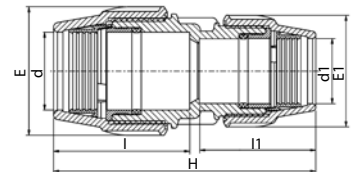

Size d x d1	E	E1	H	I	I1	UB	UC	W
75 x 50	132	96	254	141	98	—	22	894
75 x 63	132	113	261	141	112	—	18	966
90 x 63	152	113	282	152	110	—	12	1368
90 x 75	152	132	311	156	140	—	12	1608
110 x 90	181	152	377	195	162	—	8	2715

Male Adaptor

Raccord mâle
Enlace mixto rosca macho

07020

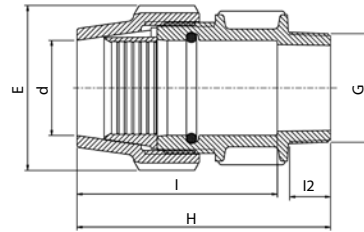

Size d x G	E	H	I	I2	UB	UC	W
16 x 3/8"	32	73	59	13	10	600	33
16 x 1/2"	39	79	59	16	10	500	34
16 x 3/4"	39	80	59	17	10	500	35
20 x 1/2"	48	91	70	17	10	350	60
20 x 3/4"	48	92	70	18	10	350	62
20 x 1"	48	88	53	20	10	350	60
25 x 1/2"	54	95	72	17	10	250	68
25 x 3/4"	54	95	72	18	10	250	76
25 x 1"	54	96	72	20	10	250	79
32 x 3/4"	64	104	82	18	5	150	107
32 x 1"	64	106	82	20	5	150	122
32 x 1 1/4"	64	110	82	22	5	150	114
32 x 1 1/2"	64	111	82	22	5	140	126
40 x 1"	82	114	86	20	—	110	191
40 x 1 1/4"	82	116	88	22	—	110	192
40 x 1 1/2"	82	119	91	22	—	100	198
40 x 2"	82	121	91	26	—	100	208
50 x 1"	96	130	105	20	—	70	265
50 x 1 1/4"	96	132	113	22	—	70	265
50 x 1 1/2"	96	135	107	22	—	70	276
50 x 2"	96	139	107	26	—	65	283
63 x 1 1/4"	113	154	125	22	—	48	405
63 x 1 1/4"	113	152	124	22	—	48	473
63 x 2"	113	167	134	26	—	48	461
63 x 2 1/2"	113	158	122	29	—	45	426

87020

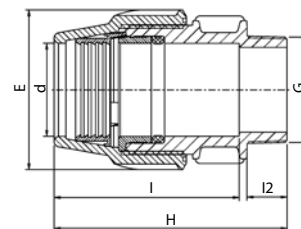

Size d x G	E	H	I	I2	UB	UC	W
75 x 2"	132	188	154	26	—	28	737
75 x 2 1/2"	132	191	154	29	—	28	752
75 x 3"	132	195	154	33	—	25	751
90 x 2"	152	240	162	26	—	16	1103
90 x 2 1/2"	152	233	160	29	—	16	1097
90 x 3"	152	230	163	33	—	16	1090
90 x 4"	152	223	181	38	—	14	1131
110 x 2"	181	263	215	26	—	8	1929
110 x 3"	181	258	215	33	—	8	1929
110 x 4"	181	267	215	42	—	8	1940

Male Integral Brass Thread

07720

Raccord de transition mâle en laiton fileté
Enlace mixto rosca macho de latón

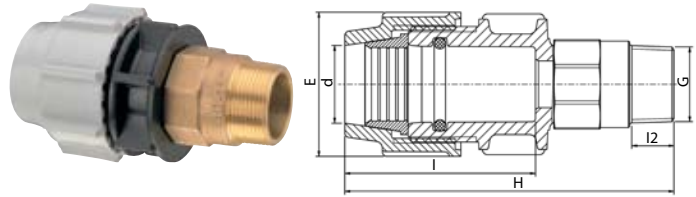

Size d x G	E	H	I	I2	UB	UC	W
32 x 3/4"	64	139	82	15	1	100	240
32 x 1"	64	141	82	20	1	100	260
32 x 1 1/4"	64	141	82	22	1	100	295
32 x 1 1/2"	64	141	82	20	1	100	320
40 x 3/4"	82	145	86	17.5	1	65	413
40 x 1"	82	147	86	20	1	65	390
40 x 1 1/4"	82	150	86	22	1	65	405
40 x 1 1/2"	82	150	86	22	1	65	410
50 x 1"	96	163	101	20	1	45	515
50 x 1 1/4"	96	168	101	22	1	45	545
50 x 1 1/2"	96	168	101	22	1	45	545
63 x 1 1/4"	113	187	124	26	1	30	820
63 x 1 1/2"	113	189	124	26	1	30	830
63 x 2"	113	193	124	26	1	30	855

Female Adaptor

07030

Raccord femelle
Enlace mixto rosca hembra

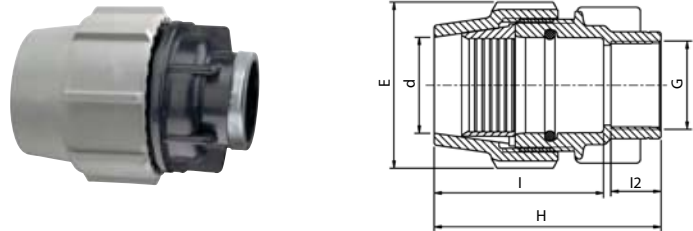

Size d x G	E	H	I	I2	UB	UC	W
16 x 1/2"	39	77	55	19	10	500	40
16 x 3/4"	39	79	56	19	10	500	36
20 x 1/2"	48	82	59	19	10	350	60
20 x 3/4"	48	82	59	19	10	350	58
20 x 1"	48	92	57	21	10	300	68
25 x 3/4"	54	89	64	21	10	250	83
25 x 1"	54	89	64	21	10	250	87
32 x 3/4"	64	85	63	19	5	150	107
32 x 1"	64	93	67	21	5	150	115
32 x 1 1/4"	64	95	66	25	5	140	140
40 x 1"	82	109	83	21	—	110	178
40 x 1 1/4"	82	107	77	25	—	110	202
40 x 1 1/2"	82	115	85	25	—	100	225
50 x 1 1/4"	96	120	89	25	—	75	275
50 x 1 1/2"	96	126	93	25	—	70	287
50 x 2"	96	129	94	30	—	70	293
63 x 1 1/4"	113	148	119	25	—	48	417
63 x 1 1/2"	113	148	119	25	—	48	420
63 x 2"	113	145	119	30	—	48	431

87030

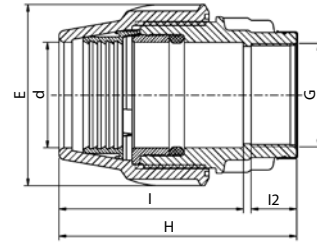

Size d x G	E	H	I	I2	UB	UC	W
75 x 2"	132	193	135	30	—	27	692
75 x 2 1/2"	132	176	135	33	—	27	730
90 x 2"	152	203	168	35	—	14	1130
90 x 3"	152	223	184	39	—	14	1196
90 x 4"	152	244	184	43	—	12	1426
110 x 3"	180	263	215	39	—	8	2003
110 x 4"	180	275	215	46	—	8	2132

Female Adaptor G

Raccord fileté femelle parallèle
Enlace mixto rosca hembra G

0703G0*

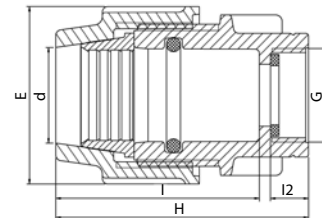

Size d x G	E	H	I	I2	UB	UC	W
25 x 3/4"	54	89	64	12	10	250	83
25 x 1"	54	89	64	14	10	250	78
32 x 1"	64	86	69	14	5	150	115

* For connecting parallel male thread
* Pour raccorder mâle parallèle fileté
* Para conectar rosca macho paralelo

Shouldered Adaptor

07320

Raccord à emboîture
Adaptador minero

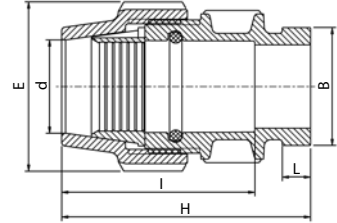

Size d x DN (inch)	E	I	L	H	B	UB	UC	W
50 x 50 (2")	96	108	16	138	67	—	65	292
63 x 50 (2")	113	123	16	156	67	—	45	437

87320

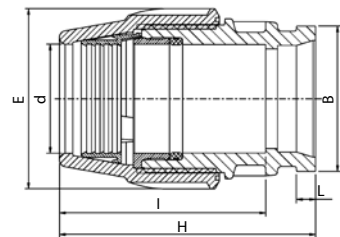

Size d x DN (inch)	E	I	L	H	B	UB	UC	W
90 x 100 (4")	152	183	16	225	123	—	14	1250
110 x 100 (4")	180.5	215	16	257	123	—	8	1964

End Plug

Bouchon mâle
Tapón final

07120

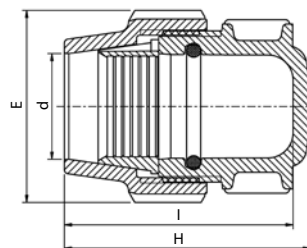

Size d	E	I	H	UB	UC	W
20	48	74	79	10	350	31
25	54	76	82	10	250	75
32	64	81	87	5	180	108
40	82	88	98	—	110	192
50	96	109	116	—	75	269
63	113	133	140	—	45	410

87120

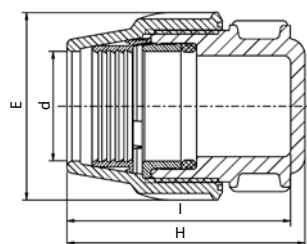

Size d	E	I	H	UB	UC	W
75	132	161	177	—	28	740
90	152	198	207	—	16	1088
110	181	215	233	—	10	1920

90° Elbow

Coude à 90°
Codo de 90°

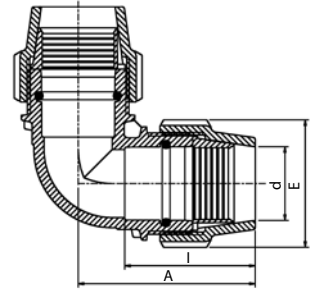

07050

Size d x d	E	I	A	UB	UC	W
16 x 16	39	51	64	10	400	57
20 x 20	48	54	73	10	200	102
25 x 25	54	57	76	10	150	126
32 x 32	64	66	92	5	100	202
40 x 40	82	83	109	—	60	356
50 x 50	96	93	123	—	35	514
63 x 63	113	110	151	—	24	796

87050

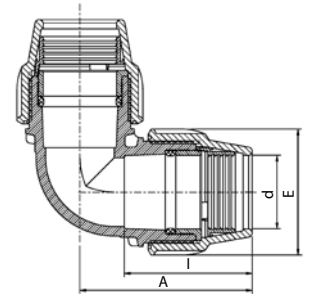

Size d x d	E	I	A	UB	UC	W
75 x 75	132	135	179	—	12	1362
90 x 90	152	163	218	—	8	2171
110 x 110	181	196	294	—	4	3997

90° Reducing Elbow

Coude de réduction à 90°
Codo de 90° reductor

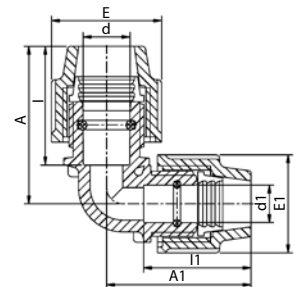

07510

Size d x D1	E	E1	I	I1	A	A1	UB	UC	W
25 x 20	54	48	57	56	86	81	10	180	114

**90° Elbow with
Threaded Male Offtake**

Coude à 90° avec dérivation filetée mâle
Codo de 90° compresión rosca macho



07850

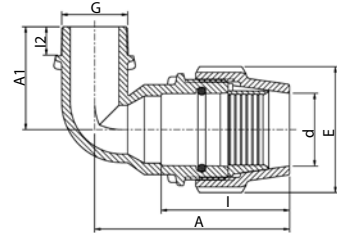

Size d x G	E	I	l2	A	A1	UB	UC	W
20 x 1/2"	48	57	17	74	41	10	320	67
20 x 3/4"	48	57	18	76	43	10	300	64
25 x 1/2"	54	58	17	85	47	10	240	73
25 x 3/4"	54	58	18	89	48	10	250	80
25 x 1"	54	58	20	89	54	10	240	90
32 x 3/4"	64	67	18	103	55	—	—	—
32 x 1"	64	67	20	103	55	5	140	128
32 x 1 1/4"	64	67	20	103	58	5	140	135
40 x 1"	82	83	20	123	60	—	90	240
40 x 1 1/4"	82	83	22	123	66	—	90	233
40 x 1 1/2"	82	83	22	123	66	—	80	241
50 x 1"	96	94	20	140	71	—	55	290
50 x 1 1/4"	96	94	22	144	74	—	55	334
50 x 1 1/2"	96	94	22	144	74	—	55	331
50 x 2"	96	94	26	144	76	—	—	—
63 x 1 1/4"	113	110	22	168	76	—	35	451
63 x 1 1/2"	113	110	22	168	76	—	35	515
63 x 2"	113	110	26	170	92	—	35	518

87850

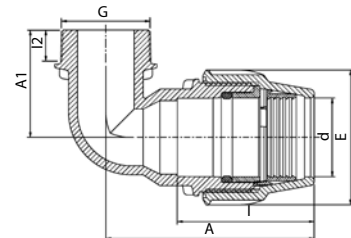

Size d x G	E	I	l2	A	A1	UB	UC	W
75 x 1 1/2"	132	136	30	206	105	—	18	886
75 x 3"	132	136	33	206	110	—	18	934
90 x 3"	152	164	34	232	110	—	12	1380
110 x 4"	181	196	43	276	140	—	6	2359

90° Elbow with Male Integral Brass

07770

Coude de transition à 90° avec filetage mâle en laiton
Codo de 90° con macho integral de latón

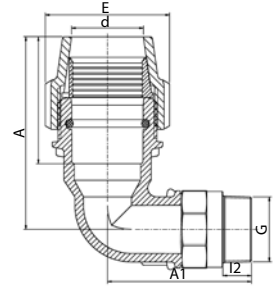

Size d x G	E	I	L2	A	A1	UB	UC	W
32 x 3/4"	64	67	17	103	79	1	100	260
32 x 1"	64	67	17	103	81	—	70	280
32 x 1 1/4"	64	67	18	103	82	—	70	310
32 x 1 1/2"	64	67	20	103	82	—	70	330
40 x 3/4"	82	83	18	123	85	—	55	435
40 x 1"	82	83	20	123	87	—	55	435
40 x 1 1/4"	82	83	22	123	90	—	55	450
40 x 1 1/2"	82	83	22	123	88	—	55	460
50 x 1"	96	94	20	140	94	—	40	560
50 x 1 1/4"	96	94	22	144	97	—	40	580
50 x 1 1/2"	96	94	22	144	97	—	40	585
63 x 1 1/4"	113	110	22	168	125	—	27	895
63 x 1 1/2"	113	110	22	168	125	—	27	915
63 x 2"	113	110	26	170	129	—	27	935

90° Elbow with Threaded Female Offtake

07150

Coude à 90° avec dérivation filetée femelle
Codo de 90° compresión rosca hembra

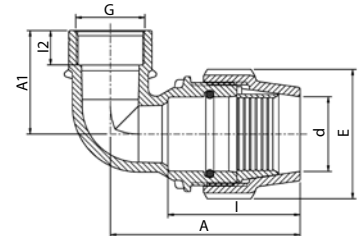

Size d x G	E	I	L2	A	A1	UB	UC	W
16 x 1/2"	39	50	19	66	39	10	500	38
20 x 1/2"	48	54	19	78	40	10	350	61
20 x 3/4"	48	52	19	72	44	10	300	71
25 x 1/2"	54	57	18	80	46	10	250	75
25 x 3/4"	54	57	19	80	46	10	250	87
25 x 1"	54	57	21	82	50	10	220	90
32 x 3/4"	64	66	18	94	54	5	150	143
32 x 1"	64	66	22	94	54	5	150	136
32 x 1 1/4"	64	66	25	98	60	5	120	167
40 x 1"	82	85	21	116	52	—	100	201
40 x 1 1/4"	82	85	25	120	61	—	90	245
40 x 1 1/2"	82	85	25	120	61	—	80	261
40 x 2"	82	85	30	125	80	—	65	293
50 x 1"	96	93	21	133	57	—	70	280
50 x 1 1/4"	96	93	25	133	67	—	60	312
50 x 1 1/2"	96	93	25	135	66	—	60	348
50 x 2"	96	93	30	138	85	—	45	384
63 x 1 1/4"	113	110	25	160	65	—	35	466
63 x 1 1/2"	113	110	25	160	69	—	35	480
63 x 2"	113	110	30	160	90	—	35	553

87150

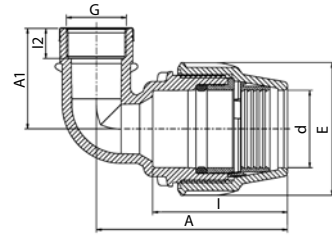

Size d x G	E	I	I2	A	A1	UB	UC	W
75 x 2"	132	136	30	191	100	—	22	860
75 x 2 1/2"	132	136	36	195	105	—	18	933
75 x 3"	132	136	36	195	105	—	18	982

45° Elbow

Coude à 45°
Codo de 45°

07060

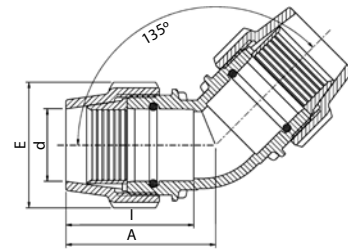

Size d x d	E	I	A	UB	UC	W
32 x 32	64	66	84	—	—	—
40 x 40	82	83	98	—	60	330
50 x 50	96	93	110	—	40	486
63 x 63	113	110	130	—	24	755

87060

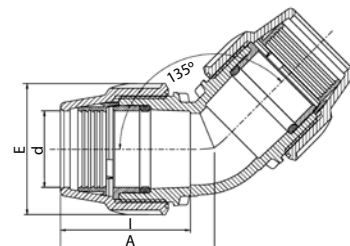

Size d x d	E	I	A	UB	UC	W
75 x 75	132	135	157	—	12	1265
90 x 90	152	162	192	—	8	2062
110 x 110	181	194	235	—	4	3575

45° Elbow with Threaded Male Offtake

07450

Coude à 45° avec dérivation fileté mâle
Codo de 45° compresión rosca macho

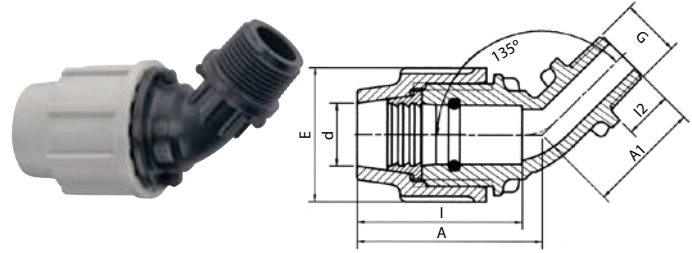

Size d x G	E	I	I2	A	A1	UB	UC	W
20 x 1/2"	48	57	17	65	40	10	350	54
20 x 3/4"	48	57	18	65	41	10	350	56

90° Elbow Adaptor

07350

Adaptateur coudé
Codo espiga

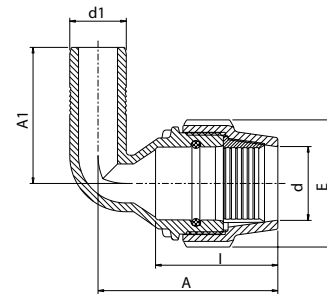

Size d x d1	E	I	A	A1	UB	UC	W
40 x 40	82	84	118	106	—	80	230
40 x 50	82	84	118	120	—	70	275
50 x 40	96	93	136	106	—	60	308
50 x 50	96	93	136	120	—	55	355
63 x 40	113	110	160	106	—	40	456
63 x 50	113	110	160	120	—	35	495

Wall Plate Elbow

07750

Coude applique murale
Codo de aplicación mural

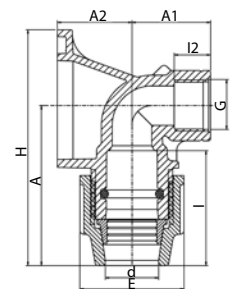

Size d x G	E	I	I2	A	A1	A2	H	UB	UC	W
16 x 1/2"	48	53	18	79	40	38	113	1	150	970
20 x 1/2"	48	58	18	79	40	38	113	1	150	92
25 x 3/4"	54	60	19	83	40	38	122	1	100	115

90° Tee

Té à 90°
Te de 90°

07040

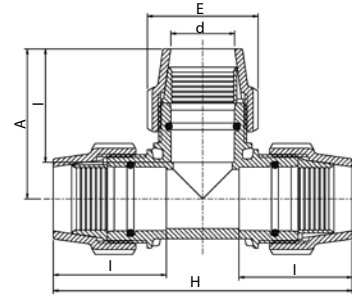

Size d x d x d	E	H	I	A	UB	UC	W
16 x 16 x 16	39	126	50	63	10	220	83
20 x 20 x 20	48	145	57	74	10	120	151
25 x 25 x 25	54	152	57	77	5	100	191
32 x 32 x 32	64	175	65	88	5	60	301
40 x 40 x 40	82	221	86	111	—	40	517
50 x 50 x 50	96	252	95	126	—	25	748
63 x 63 x 63	113	292	109	146	—	16	1145

87040

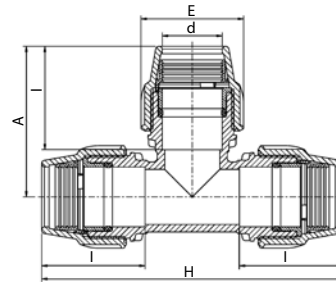

Size d x d x d	E	H	I	A	UB	UC	W
75 x 75 x 75	132	359	141	180	—	8	1947
90 x 90 x 90	152	436	163	218	—	8	3165
110 x 110 x 110	181	588	196	294	—	2	5868

90° SlipTee

Té à 90° de réparation
Te de 90° de reparación

0704P0

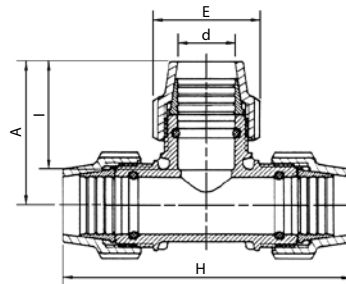

Size d x d x d	E	H	I	A	UB	UC	W
20 x 20 x 20	48	145	57	74	10	140	146
25 x 25 x 25	54	152	57	77	5	100	185
32 x 32 x 32	64	175	65	88	5	60	294
40 x 40 x 40	82	221	84	111	—	40	509
50 x 50 x 50	96	251	93	126	—	25	735
63 x 63 x 63	113	292	109	146	—	16	1125

90° Enlarging Tee

Té agrandisseur
Te de alargado

07740

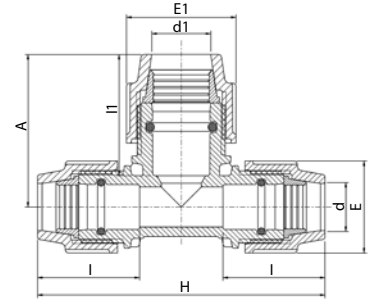

Size d x d1 x d	E	E1	H	I	I1	A	UB	UC	W
25 x 25 x 25	54	64	152	59	65	91	5	80	—

90° Reducing Tee

Té à 90° de réduction
Te de 90° reductor

07340

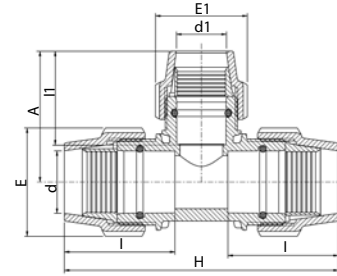

Size d x d1 x d	E	E1	H	I	I1	A	UB	UC	W
20 x 16 x 20	48	39	142	60	53	65	10	150	125
25 x 20 x 25	53	48	154	60	58	76	5	100	178
32 x 25 x 32	63	53	171	66	60	85	5	70	266
40 x 25 x 40	82	53	202	82	60	85	—	45	405
40 x 32 x 40	82	63	209	82	66	96	—	40	441
50 x 25 x 50	96	53	222	93	78	107	—	30	587
50 x 32 x 50	96	63	222	93	66	116	—	30	613
50 x 40 x 50	96	82	236	93	82	114	—	30	657
63 x 32 x 63	113	63	266	112	66	116	—	20	893
63 x 40 x 63	113	82	266	112	84	139	—	20	945
63 x 50 x 63	113	96	273	109	93	135	—	18	1005

87340

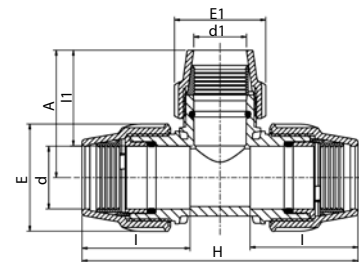

Size d x d1 x d	E	E1	H	I	I1	A	UB	UC	W
75 x 63 x 75	132	113	360	141	109	156	—	10	1668

90° Tee with Threaded Male Offtake

07840

Té à 90° avec dérivation fileté mâle
Te de 90° compresión rosca macho

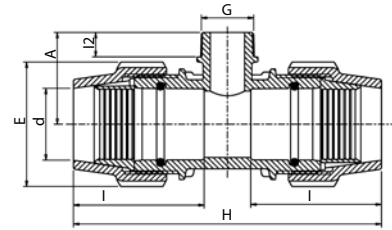

Size d x G x d	E	H	I	I2	A	UB	UC	W
20 x 1/2" x 20	48	144	57	19	42	10	180	113
20 x 3/4" x 20	48	144	57	19	45	10	180	110
25 x 1/2" x 25	54	150	58	19	45	5	140	126
32 x 1" x 32	64	174	66	21	54	5	80	213
40 x 1 1/4" x 40	82	208	83	24	63	—	55	403
40 x 1 1/2" x 40	82	216	81	25	76	—	50	453
50 x 1 1/2" x 50	96	242	93	25	78	—	36	602
50 x 2" x 50	96	244	93	30	87	—	30	599
63 x 1 1/4" x 63	113	291	110	25	95	—	20	875
63 x 1 1/2" x 63	113	291	110	25	95	—	20	866
63 x 2" x 63	113	291	110	30	95	—	20	904

90° Reducing Tee with Threaded Female Offtake

071450

Té à 90° de réduction avec dérivation fileté femelle
Te de 90° reducción compresión rosca hembra

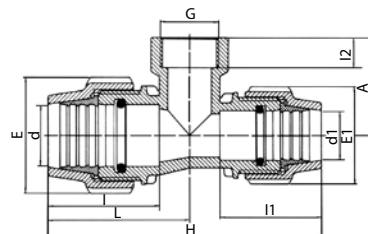

Size d x G x d	E	E1	H	L	I	I1	I2	A	UB	UC	W
20 x 3/4" x 16	48	39	133	70	53	50	19	42	10	180	86
25 x 3/4" x 20	54	48	141	72	54	53	22	42	5	140	141
32 x 1" x 25	64	54	172	95	67	62	22	66	5	100	223

90° Tee with Threaded Female Offtake

Té à 90° avec dérivation fileté femelle
Te de 90° compresión rosca hembra

07140

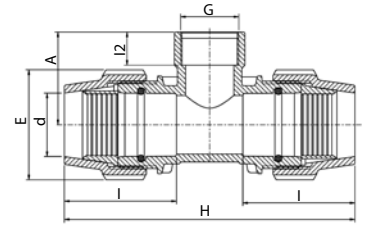

Size d x G x d	E	H	I	I2	A	UB	UC	W
16 x 1/2" x 16	39	124	51	18	41	10	240	66
16 x 3/4" x 16	39	124	51	19	42	10	240	65
20 x 1/2" x 20	48	144	57	19	42	10	180	113
20 x 3/4" x 20	48	144	57	19	45	10	180	110
25 x 1/2" x 25	54	150	58	19	45	5	140	126
25 x 3/4" x 25	54	150	58	19	48	5	140	140
25 x 1" x 25	54	158	63	21	66	5	100	162
25 x 1 1/4" x 25	54	158	63	25	74	5	100	194
32 x 3/4" x 32	64	174	66	19	51	5	80	177
32 x 1" x 32	64	174	66	21	54	5	80	213
32 x 1 1/4" x 32	64	180	72	25	67	5	60	268
32 x 1 1/2" x 32	64	178	70	25	71	5	60	282
40 x 1" x 40	82	200	80	20	61	—	60	356
40 x 1 1/4" x 40	82	208	83	24	63	—	55	403
40 x 1 1/2" x 40	82	216	81	25	76	—	50	453
40 x 2" x 40	82	218	85	30	84	—	45	435
50 x 1 1/2" x 50	96	242	93	25	78	—	36	602
50 x 2" x 50	96	244	93	30	87	—	30	599
63 x 1 1/4" x 63	113	291	110	25	95	—	20	875
63 x 1 1/2" x 63	113	291	110	25	95	—	20	866
63 x 2" x 63	113	291	110	30	95	—	20	904

87140

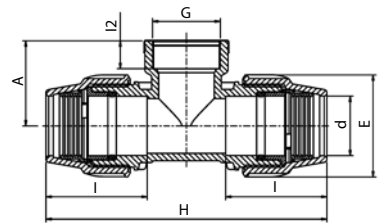

Size d x G x d	E	H	I	I2	A	UB	UC	W
75 x 2" x 75	132	366	135	30	110	—	9	1517
75 x 2 1/2" x 75	132	338	132	35	85	—	9	1570
75 x 3" x 75	132	366	135	36	110	—	9	1627
90 x 3" x 90	152	413	162	41	116	—	7	2351
110 x 4" x 110	181	511	198	52	140	—	4	4189

90° Slip Tee with Threaded Female Offtake

0714P0

Té à 90° de réparation avec dérivation fileté femelle
Te de 90° roscas hembra de reparación

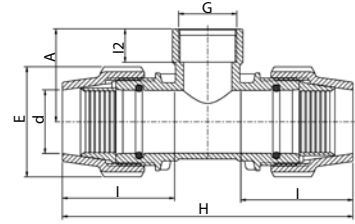

Size d x G x d	E	H	I	I2	A	UB	UC	W
40 x 1" x 40	82	200	80	20	61	—	60	356
50 x 1 1/2" x 50	96	242	93	25	78	—	36	602
63 x 1 1/4" x 63	113	291	110	25	95	—	20	875

Coupling with Riser

07810

Té à 90° avec dérivation fileté longue
Enlace recto con derivación rosca macho

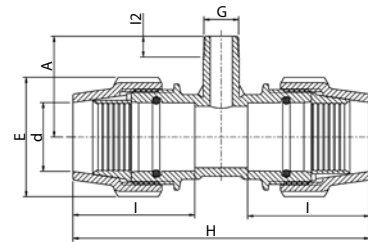

Size d x G x d	E	I	I2	H	A	UB	UC	W
40 x 3/4" x 40	82	89	18	216	85	—	50	372
50 x 3/4" x 50	96	98	18	244	90	—	36	525
50 x 1" x 50	96	98	20	244	90	—	36	550
63 x 3/4" x 63	113	110	18	270	95	—	24	781
63 x 1" x 63	113	110	20	270	95	—	24	821

87810

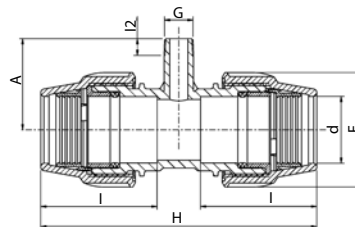

Size d x G x d	E	I	I2	H	A	UB	UC	W
75 x 3/4" x 75	132	136	18	322	105	—	12	1300
75 x 1" x 75	132	136	20	322	105	—	12	1310

45° Tee

Té à 45°
Te de 45°

07640

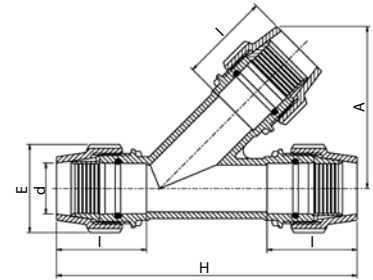

Size d x d x d	E	H	I	A	UB	UC	W
63 x 63 x 63	113	373	110	207	—	10	1390

87640

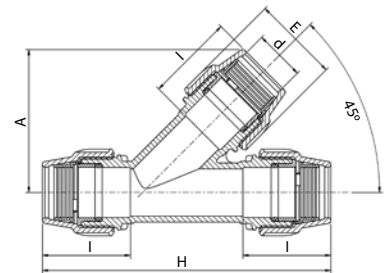

Size d x d x d	E	H	I	A	UB	UC	W
75 x 75 x 75	132	442	135	204	—	6	2500
90 x 90 x 90	152	514	162	233	—	4	3674
110 x 110 x 110	181	625	194	284	—	2	6229

Compression Flange Adaptor (with Metal Flange)

07220*

Raccord à bride (avec bride de métal)
Adaptador compresión-brida (con brida de metal)

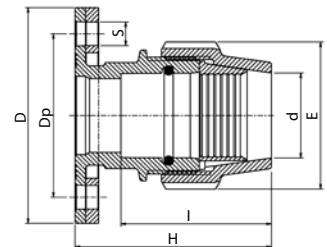

Size d x DN (inch)	E	H	I	D	Dp	S	No. of Holes	Metal-Flange Size	UC	W
40 x 40 (1 1/2")	82	85	50	150	110	18	4	40 x 40	20	1200
50 x 40 (1 1/2")	96	128	93	150	110	18	4	50 x 40	20	1198
50 x 50 (2")	96	128	93	165	125	18	4	50 x 50	15	1595
63 x 50 (2")	113	145	110	165	125	18	4	63 / 75 x 50	15	1509
125 x 125 (5")	212	270	250	250	210	22	8	125 / 160 x 125	4	3232
125 x 150 (6")	212	270	250	285	240	22	8	125 / 160 x 150	3	3450

* 072210 - Compression Flange Adaptor without metal flange

* 072210 - Raccord à bride sans bride de métal

* 072210 - Sin brida de metal

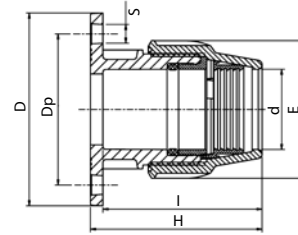
87220*

Size d x DN (inch)	E	H	I	D	Dp	S	No. of Holes	Metal-Flange Size	UC	W
75 x 65 (2 1/2")	132	165	153	185	145	18	4	75 / 90 x 65	12	2200
90 x 80 (3")	152	192	180	200	160	18	8	90 / 110 x 80	10	2429
90 x 100 (4")	152	192	180	220	180	18	8	90 x 100	8	3012
110 x 100 (4")	181	225	212	216	180	18	8	110 x 100	8	3398

* 872210 - Compression flange adaptor without metal flange

* 872210 - Raccord à bride sans bride de métal

* 872210 - Sin brida de metal

Flange Adaptor (with Metal Flange)

Adaptateur à bride (avec bride de métal)
Adaptador espiga-brida (con brida de metal)

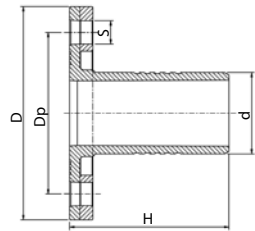

072306*

Size d x DN (inch)	H	D	Dp	S	No. of Holes	Metal-Flange Size	UC	W
50 x 40 (1 1/2")	99	150	110	18	4	50 x 40	20	1064
50 x 50 (2")	99	165	125	18	4	50 x 50	20	1094
63 x 50 (2")	124	165	125	18	4	63 / 75 x 50	18	1311
63 x 65 (2 1/2")	124	185	145	18	4	63 x 65	15	1787

* 072301 - Flange adaptor without metal flange

* 072301 - Adaptateur à bride sans bride de métal

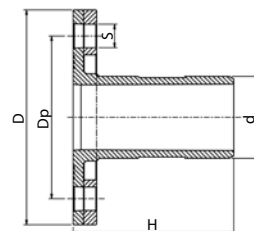
* 072301 - Sin brida de metal

872306*

Size d x DN (inch)	H	D	Dp	S	No. of Holes	Metal-Flange Size	UC	W
75 x 50 (2")	142	165	125	18	4	63 / 75 x 50	15	1402
75 x 65 (2 1/2")	142	185	145	18	4	75 / 90 x 65	15	1568
75 x 80 (3")	142	200	160	18	8	75 x 80	12	1981
90 x 65 (2 1/2")	175	185	145	18	4	75 / 90 x 65	12	1755
90 x 80 (3")	175	200	160	18	8	90 / 110 x 80	12	1858
90 x 100 (4")	175	220	180	18	8	90 x 100	10	2181
110 x 80 (3")	210	200	160	18	8	90 / 110 x 80	10	2020
110 x 100 (4")	210	220	180	18	8	100 x 100	8	2330
110 x 125 (5")	214	250	210	18	8	110 x 125	6	3988

* 872301 - Flange adaptor without metal flange

* 872301 - Adaptateur à bride sans bride de métal

* 872301 - Sin brida de metal

Metal Flange

Bride de métal
Brida de metal

07006

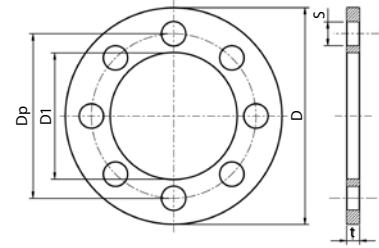

Size d x DN (inch)	D	Dp	D1	S	t	Th*		No. of Holes	W
						mm	inch		
50 x 40 (1 1/2")	150	110	82	18	10	M16	37472	4	877
50 x 50 (2")	165	125	82	18	10	M16	37472	4	877
63 / 75 x 50 (2")	165	125	96	18	10	M16	37472	4	1035
63 x 65 (2 1/2")	185	145	96	18	10	M16	37472	4	1490
75 / 90 x 65 (2 1/2")	185	145	112	18	10	M16	37472	4	1141
75 x 80 (3")	200	160	112	18	10	M16	37472	8	1650
90 / 110 x 80 (3")	200	160	132	18	10	M16	37472	8	1200
90 x 100 (4")	220	180	132	18	10	M16	37472	8	1734
110 x 100 (4")	220	180	151	18	10	M16	37472	8	1416
110 x 125 (5")	250	210	151	18	10	M16	37472	8	2880

* nominal diameter of bolts
* diamètre nominal de l'écrou
* diametro nominal del tornillo

Threaded Adaptor

Adaptateur fileté
Adaptador compresión rosca macho

07250*

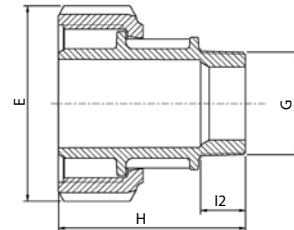

Size d x G	E	H	I2	UB	UC	W
25 x 1/2"	54	79	17	2	200	36
25 x 3/4"	54	80	18	2	200	36
32 x 1/2"	64	85	17	2	180	66
32 x 3/4"	64	86	18	2	180	65
32 x 1"	64	87	20	2	180	68
40 x 1"	82	95	20	2	130	106
40 x 1 1/4"	82	96	22	2	130	112
40 x 1 1/2"	82	96	22	2	130	108
50 x 1"	96	102	22	2	80	147
50 x 1 1/4"	96	104	22	2	80	148
50 x 1 1/2"	96	104	22	2	80	149
50 x 2"	96	107	27	2	80	158
63 x 1"	113	118	20	2	60	228
63 x 1 1/4"	113	121	22	2	60	230
63 x 1 1/2"	113	121	22	2	60	230
63 x 2"	113	124	26	2	60	236
63 x 2 1/2"	113	126	29	2	60	250
75 x 1 1/2"	134	128	22	2	30	404
75 x 2"	134	132	26	2	30	402
75 x 2 1/2"	134	134	29	2	30	412
75 x 3"	134	137	33	2	30	430

* Threaded Adaptor Body Cat. No. 078901. Threaded Adaptor Nut - Cat. No. 078940
* Corps de l'adaptateur fileté - Cat. No. 078901. Ecrou pour adaptateur fileté - Cat. No. 078940
* Cuerpo del adaptador roscado - Cat. No. 078901. Racor para el adaptador roscado - Cat. No. 078940

Brass Threaded Adaptor

07270

Adaptateur en laiton fileté
Adaptador rosca de latón

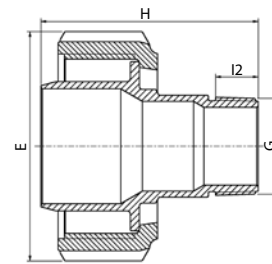

Size d x G	G	I2	H	E	UB	UC	W
32 x 1"	33	19	77	64	1	50	279
40 x 1"	33	19	81	82	1	50	363
40 x 1 1/4"	41	21	90	82	1	50	487
50 x 1 1/4"	41	21	95	96	1	30	523
50 x 1 1/2"	47	21	97	96	1	30	554
63 x 1 1/4"	41	21	105	113	1	20	767
63 x 1 1/2"	47	21	107	113	1	20	762
63 x 2"	59	25	112	113	1	20	973

Plass4 Coupling

070170

(Universal)

Plass4 - Manchon (universel)
Plass4 Enlace (universal)

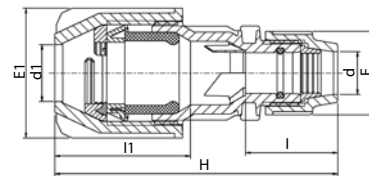

Size d x d1	E	E1	I	I1	H	UB	UC	W
25 x 15 - 22	54	64	60	80	165	1	90	195
25 x 20 - 27	54	71	60	85	170	1	80	238
25 x 27 - 35	54	83	60	90	180	1	60	305
32 x 20 - 27	63	71	70	85	180	1	70	236
32 x 27 - 35	63	83	70	90	195	1	60	312
50 x 35 - 50	96	120	90	125	270	1	20	900

Plass4 (Universal) 90° Elbow

070570

Plass4 - coude à 90° (universel)
Plass4 - Codo de 90° (universal)

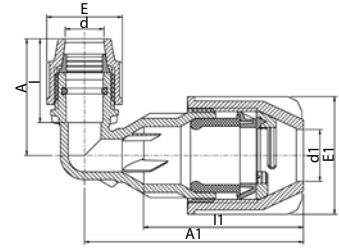

Size d x d1	E	E1	I	I1	A	A1	UB	UC	W
25 x 15 - 22	54	64	60	105	13	128	1	90	183
25 x 20 - 27	54	71	60	105	83	139	1	80	222
25 x 27 - 35	54	83	60	112	83	153	1	60	290

Y-Fitting with Threaded Male Offtake

07550

Raccord Y avec dérivation fileté mâle
Y compresión rosca macho

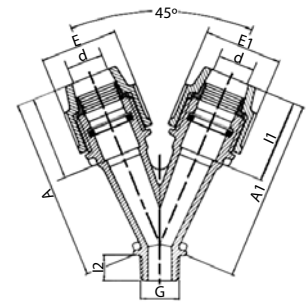

Size d x d x G	E	E1	I	I1	I2	A	A1	UB	UC	W
16 x 16 x 3/4"	39	39	50	50	18	98	98	10	200	75
20 x 16 x 3/4"*	48	39	58	51	18	104	100	10	180	103
20 x 20 x 3/4"	48	48	58	58	18	115	115	10	140	130
25 x 25 x 3/4"	54	54	58	58	18	125	125	5	100	154

* In this case diameter should read: d x d x G

* dans ce cas le diamètre doit se lire: d x d x G

* en este caso el diametro debe leido: d x d x G

Cross with Threaded Female Offtake

07540

Croix avec dérivation fileté femelle
Cruz compresión rosca hembra

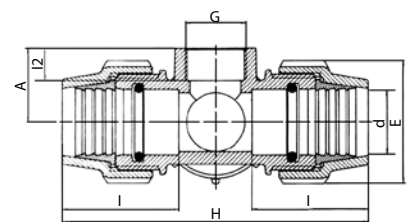

Size d x d x d x d x G	E	I	I2	H	A	UB	UC	W
20 x 20 x 20 x 20 x 3/4"	48	58	21	151	34	5	80	204

Plug Adaptor

Bouchon universel
Tapón ciego

071209

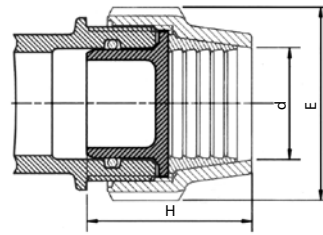

Size d	E	E1	UB	UC	W
20	48	47	10	3000	4
25	54	51	10	2000	7
32	64	56	10	1000	15
40	82	66	—	720	24
50	96	80	—	400	38
63	113	96	—	200	76

Pipe Liner for PE SDR 11 Pipe

Renfort pour tuyau PE SDR 11
Refuerzo de tubos

07950

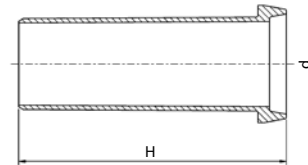

Size d *	H	UB	UC	W
20 x 2.3	65	10	3000	6
25 x 2.3	67	10	1800	11
32 x 3.0	84	10	900	18
40 x 3.7	97	—	480	26
50 x 4.6	125	10	250	56
63 x 5.8	146	5	130	90

* O.D. of pipe x wall thickness of pipe

* O.D. du tuyau x épaisseur du mur

* diametro externo del tubo x espesor del tubo

Adaptor for Copper and Imperial UPVC

Adaptateur pour tube en cuivre et UPVC impérial
Adaptador para cobre y PVCU

07896*

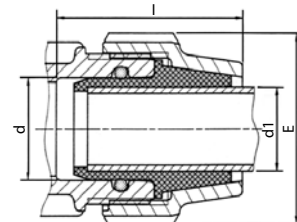

Size d x d1	E	I	UB	UC	W
20 x 15	48	66	25	1500	15
25 x 22	54	64	10	1200	16
32 x 28	64	74	10	700	28
40 x 35	82	92	10	300	54
50 x 42	96	105	10	160	108

* No Pull-Out Resistance

* Sans résistance à la traction

* Sin resistencia a la tracción

Reducing Set

Set de réduction
Juego reductor

07930*

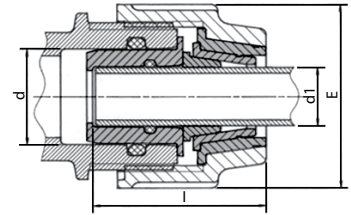

Size d x d1	E	I	UB	UC	W
25 x 20	54	56	—	300	23
32 x 20	64	62	—	300	38
32 x 25	64	60	—	250	35
40 x 20	82	73	—	180	62
40 x 25	82	69	—	180	81
40 x 32	82	77	—	200	62
50 x 25	96	85	—	120	111
50 x 32	96	87	—	120	112
50 x 40	96	85	—	120	97
63 x 25	113	103	—	80	217
63 x 32	113	102	—	80	206
63 x 40	113	103	—	80	204
63 x 50	113	105	—	80	186
110 x 63	180	131	—	—	—

* Reducer made of rubber

* La réduction est faite en plastique

* Reductor de goma

87930

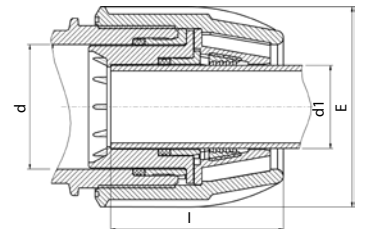

Size d x d1	E	I	UB	UC	W
75 x 63*	132	121	1	70	220
110 x 75	181	145	1	25	114
110 x 90	181	154	1	20	638

* Assembled with out the inserts

Modular Adaptor

Adaptateur module
Adaptador modulado

07940

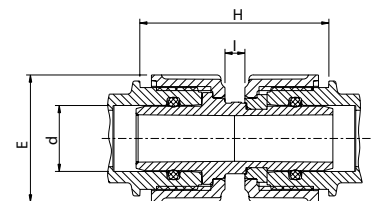

Size d	E	H	I	UB	UC	W
20	48	80	10	—	300	50
25	54	80	10	—	250	60
32	64	93	10	—	180	101
40	82	102	10	—	100	170
50	96	107	10	—	70	255
63	113	119	10	—	45	385

Copper Pipe Adaptor

Adaptateur pour tube en cuivre
Adaptador para tubo de cobre

0701C0

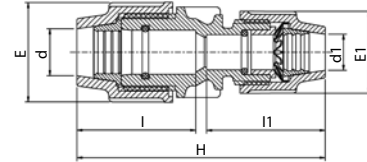

Size d (PE) x d1 (Cu)	E	E1	H	I	I1	UB	UC	W
20 x 15	48	39	115	56	54	—	300	74
25 x 15	54	39	124	55	54	—	220	86
25 x 22	54	54	136	60	71	—	150	—
32 x 28	64	64	150	70	77	—	100	—

PB Pipe Adaptor

Adaptateur pour tube plomb
Adaptador para tubo plomo

0711B0 / 0701B0

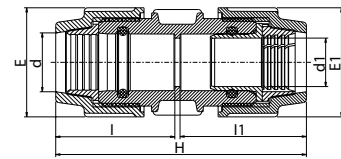

Size d (PE) x d1 (PB)	E	E1	H	I	I1	UB	UC	W
20 x 15	48	48	115	56	54	10	200	52
25 x 15	54	48	124	55	54	10	180	120
25 x 22	54	54	136	60	71	10	180	120
32 x 28	64	64	149	70	74	—	100	—

Grip Ring for UPVC and PP pipe

Rondelle de retenue en inox pour tube UPVC et PP
Casquillo de apriete para tubos de UPVC y PP

07970

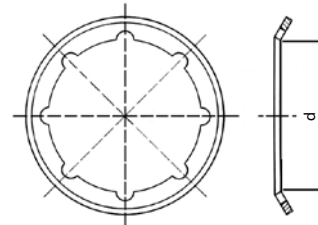

Size d	UB	UC	W
20	10	—	2
25	10	—	2
32	10	—	4
40	10	—	6
50	10	—	11
63	10	—	18

Conversion Set for Copper Pipe

07438

Set de conversion pour tube en cuivre
Juego adaptador para tubos de cobre

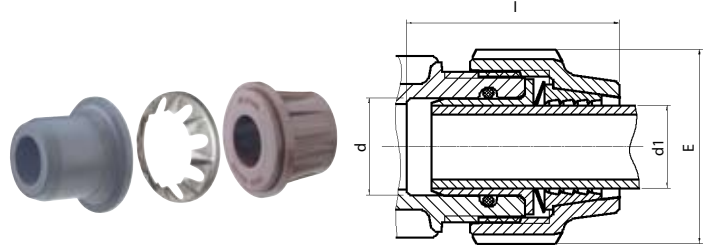

Size d x d1	E	I	UB	UC	W
20 x 15	48	67	10	360	20
25 x 15	54	69	10	360	33
25 x 22	54	67	10	360	23
32 x 28	64	77	10	300	35
40 x 35	82	92	10	300	38
50 x 42	96	105	10	250	64
63 x 54	113	121	1	150	102

CTS dimensions

Dimensions CTS

Dimensiones CTS

Size d x d1	E	I	UB	UC	W
20 x 1/2" (O.D. 15.8mm)	48	67	10	600	20
25 x 3/4" (O.D. 22.2mm)	54	69	10	500	33

Australian dimensions (AS 1432)

Dimensions Australiennes (AS 1432)

Dimensiones Australianas (AS 1432)

Size d x d1	E	I	UB	UC	W
20 x 15 (1/2") (O.D. 12.7mm)	48	67	10	600	20
25 x 20 (3/4") (O.D. 19.5mm)	54	69	10	500	33
25 x 25 (1") (O.D. 25.4mm)	54	69	10	500	33

Conversion Set for Lead Pipe

077802

Set de conversion pour tube en plomb
Juego adaptador para tubos de plomo

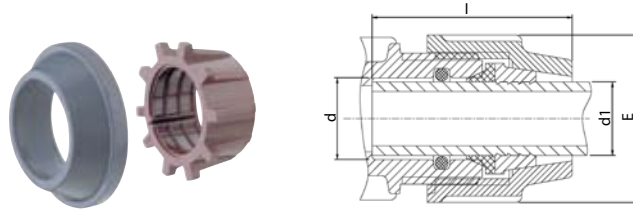

Size d x d1	E	I	UB	UC	W
25 x 3/8" 5 LB	54	67	20	1000	80
25 x 1/2" 7 LB	54	64	20	1800	150
32 x 1/2" 9 LB	64	77	10	500	235
32 x 3/4" 9 LB	64	76	10	1000	130
40 x 3/4" 11 LB	82	95	10	400	420
50 x 1" 16 LB	96	104	5	250	680

Converter Rubber Adaptor for Galvanised Pipe

078908*

Joint convertisseur adaptateur pour tube en acier galvanisé
Conversor de goma para tubos de acero galvanizado

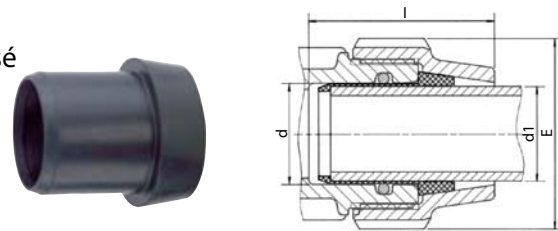

Size d x d1	E	I	UB	UC	W
40 x 1"	82	89	5	200	60
50 x 1 1/4"	96	98	5	150	71
50 x 1 1/2"	96	90	5	150	36
63 x 2"	113	108	5	120	89

* Without pullout resistance

* Sans résistance de dégagement

* Extraccion sin resistencia

Conversion Set Adaptor for Galvanised Pipe

078907

Set de conversion adaptateur pour tube en acier galvanisé
Juego de conversion para tubos de acero galvanizado

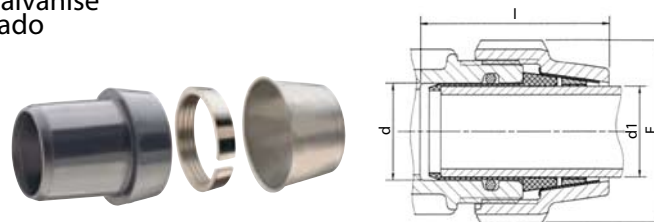

Size d x d1	E	I	UB	UC	W
40 x 1"	82	96	5	200	117
50 x 1 1/4"	96	105	5	150	182
50 x 1 1/2"	96	115	5	150	125
63 x 2"	113	117	5	120	226

Metric PE / Metric U-PVC / Metric PP / Galvanised Steel / Lead Pipe / Imperial U-PVC/Copper

**Polyéthylène métrique / U-PVC métrique / PP métrique / Acier galvanisé / Plomb / U-PVC impérial / Cuivre...
PE métrico / PP y PVCU métrico / Acero galvanizado / Plomo / U-PVC imperial / Cobre...**

The basic fitting is a dedicated product for joining metric PE pipe. It will securely join the pipe without any additional components. The fittings can be easily converted for use with other materials simply by adding a conversion set. Plasson offers a full range of conversion sets to provide exceptional adaptability.

Les raccords standards Plasson sont spécialement conçus pour les tubes polyéthylène. Ils assurent une parfaite sécurité sans composant supplémentaire nécessaire. Ils peuvent aussi facilement être convertis pour s'adapter à d'autres tubes, en ajoutant simplement un set de conversion. Plasson offre une gamme complète de sets de conversion convenant à tous types de réseaux.

El accesorio básico es un producto dedicado a conectar tuberías de PE sin componentes adicionales, con la máxima seguridad. Los accesorios se pueden ser convertidos facilmente a cualquier tipo de tubería usando un juego de conversión. Plasson ofrece una gama que permite una adaptabilidad excepcional.

Copper (without pullout resistance)
Cuivre (sans résistance à la traction)
Cobre (sin resistencia a tracción)



Metric PE
Polyéthylène métrique
PE métrico

Metric U-PVC & PP
U-PVC et PP métrique
PVC - U y PP métrico



Copper
Cuivre
Cobre

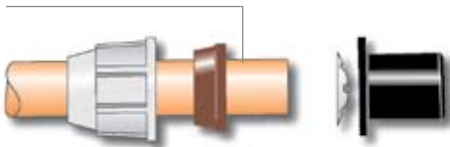

Galvanised steel (without pullout resistance)
Acier galvanisé (sans résistance à la traction)
Acero galvanizado (sin resistencia a tracción)



Imperial U-PVC (without pullout resistance)
U-PVC impérial (sans résistance à la traction)
U-PVC imperial (sin resistencia a tracción)



Galvanised steel
Acier galvanisé
Acero galvanizado



Lead pipe
Plomb
Plomo

Nut

Ecrou de serrage (PP)
Racor

07004

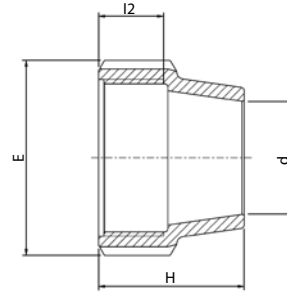

Size d x d1	E	H	l2	UB	UC	W
16	39	40	23	—	—	12
20	48	45	26	—	—	22
25	54	46	26	—	—	29
32	64	51	30	—	—	43
40	82	63	34	—	—	70
50	96	71	34	—	—	105
63	113	89	43	—	—	159
125	212	185	107	—	—	1135

87004

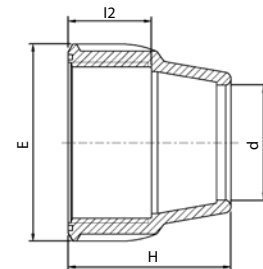

Size d	E	H	l2	UB	UC	W
75	132	110	56	—	50	291
90	153	135	73	—	30	447
110	181	170	97	—	16	827

O - Ring NBR

Joint torique nitrile (NBR)
Junta tórica (NBR)

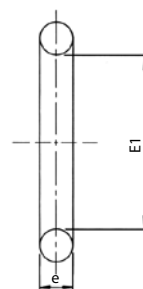

07002

Size d	E1	e	UB	UC	W
16	15	3	—	—	—
20	19	3	—	—	—
25	24	4	—	—	—
32	31	5	—	—	—
125	122	10	—	—	—

O - Ring EPDM

(Blue Mark)

Joint torique EPDM, (marque bleue)
Junta tórica EPDM, (marca azul)

Size d	E1	e	UB	UC	W
16	15	3	—	—	—
20	19	3	—	—	—
25	24	4	—	—	1
32	31	5	—	—	2

07002D0

O - Ring Viton FPM

(White Mark)

Joint torique Viton (FPM), (marque blanche)
Junta tórica FPM, (marca blanca)

Size d	E1	e	UB	UC	W
20	19	3	—	—	—
25	24	4	—	—	2
32	31	5	—	—	4

07002V0

Seal - NBR

Joint - NBR
Sello de NBR

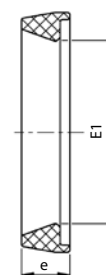

070029

Size d	E1	e	UB	UC	W
40	38	8	—	—	5
50	49	9	—	—	8
63	62	9	—	—	10

Seal - EPDM

Joint - EPDM
Sello de EPDM

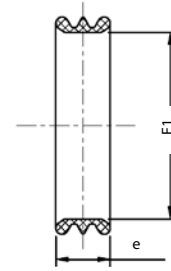

87910

Size d	E1	e	UB	UC	W
75	77	22	—	400	26
90	92	22	—	300	35
110	112	24	—	250	45

Seal EPDM

(Blue Mark)

Joint EPDM, (marque bleue)
Sello EPDM, (marca azul)

Size d	E1	e	UB	UC	W
40	39	6	—	—	4
50	49	7	—	—	7
63	62	7	—	—	9

07002D9

Seal Viton FPM

(White Mark)

Joint - Viton FPM, (marque blanche)
Sello de Viton FPM, (marca blanca)

Size d	E1	e	UB	UC	W
40	39	6	—	—	7
50	49	7	—	—	12
63	62	7	—	—	15

07002V9

Seal Viton FPM

(White Mark)

Joint - Viton FPM, (marque blanche)
Sello de Viton FPM, (marca blanca)

Size d	E1	e	UB	UC	W
75	74	8	—	—	23
90	89	8	—	—	28
110	108	9	—	—	43

87920

Split Ring - Polyacetal

07003

Bague de crampage, acétal (POM)
Casquillo de apriete (acetal)

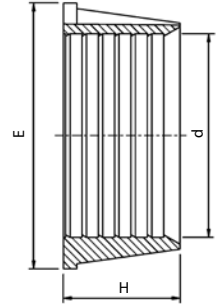

Size d	E	H	UB	UC	W
16	23	12	100	12000	1
20	31	13	100	6500	2
25	36	13	100	5000	4
32	44	19	50	2200	9
40	55	24	50	1200	12
50	67	30	20	500	24
63	83	37	10	300	47
125	161	72	—	—	—

Split Ring - Polyacetal

87003

Bague de crampage, acétal (POM)
Casquillo de apriete (acetal)

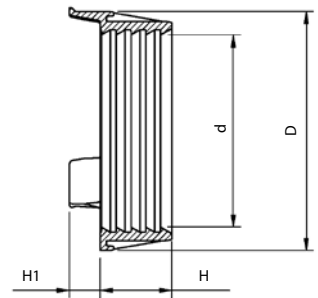

Size d	D	H	H1	UB	UC	W
75	89	29	13	—	300	52
90	105	34	14	—	150	76
110	126	44	16	—	80	133

Split Ring - CPVC

Bague de crantage CPVC
Casquilla de apriete (CPVC)

07003V

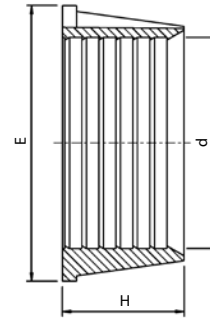

Size d	E	H	UB	UC	W
16	23	12	100	12000	2
20	31	13	100	6500	4
25	36	13	100	5000	5
32	44	19	50	2200	10
40	55	24	50	1200	19
50	67	30	20	500	32
63	83	37	10	300	53

Split Ring - CPVC

Bague de crantage CPVC
Casquilla de apriete (CPVC)

87003V

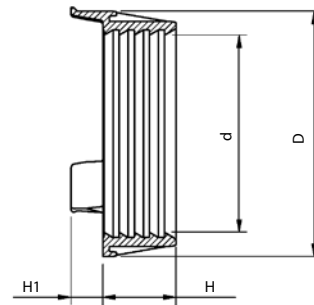

Size d	D	H	H1	UB	UC	W
75	89	29	13	—	300	60
90	105	34	14	—	150	90
110	126	44	16	—	80	152

Insert

Insert (PP)
Inserto de PP

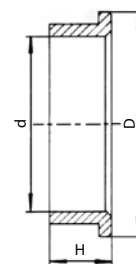

07005

Size d	D	H	UB	UC	W
16	—	—	—	—	—
125 Upper	164	48	—	—	154
125 Lower	142	18	—	—	43

87005



Size d	D	H	UB	UC	W
75	94	23	—	300	37
90	116	32	—	200	48
110	138	36	—	100	80

Chamfer Tool for PE Pipes

Outil à chanfreiner pour tuyaux PE
Herramienta para biselar



07960

Size	UB	UC	W
20 - 63	—	64	202

Plasson Wrench

Clé Plasson
Llave Plasson



07990

Size	UB	UC	W
16 - 40	—	250	65
40 - 75	—	75	296
63 - 125	—	40	840

Coupling

Manchon
Enlace recto

070106

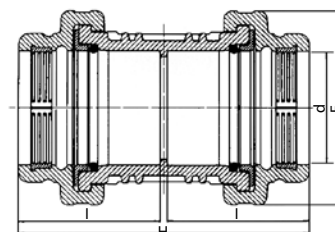

Size d x d	E	I	H	UB	UC	W
160 x 160	280	204	418	—	2	9185

Repair Coupling

Manchon de réparation
Enlace recto de reparación

076106

Size d x d	E	I	H	UB	UC	W
160 x 160	280	—	418	—	2	9185

90° Tee

Té à 90°
Té de 90°

070406

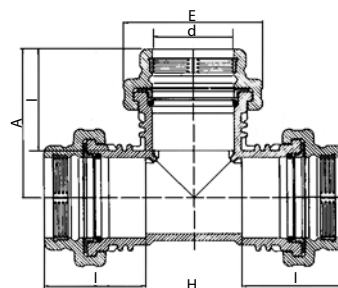

Size d x d x d	E	I	H	A	UB	UC	W
160 x 160 x 160	280	204	601	301	—	1	14738

90° Elbow

Coude à 90°
Codo de 90°

070506

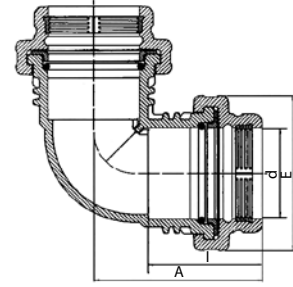

Size d x d	E	I	A	UB	UC	W
160 x 160	280	204	301	—	2	10232

Compression Flange Adaptor (with Metal Flange)

Raccord à bride (avec bride de métal)
Adaptador compresión-brida (con brida de metal)

072206

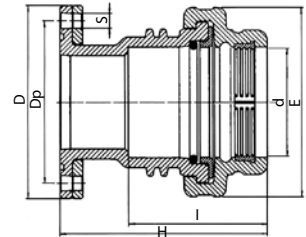
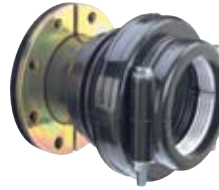

Size d x DN (inch)	E	H	I	D	Dp	S	No. of Holes	Metal-Flange Size	UC	W
160 x 125 (5")	280	304	204	250	210	18	8	125 / 160 x 125	3	9095
160 x 150 (6")	280	304	204	285	240	22	8	125 / 160 x 150	3	9350

Flange Adaptor (with Metal Flange)

Adaptateur à bride (avec bride de métal)
Adaptador brida (con brida de metal)

072306

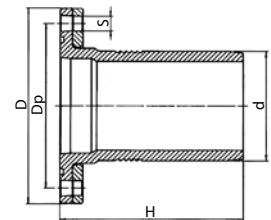

Size d x DN (inch)	H	D	Dp	S	No. of Holes	Metal-Flange Size	UC	W
160 x 125 (5")	265	250	210	18	8	125 / 160 x 125	6	4345
160 x 150 (6")	265	285	240	22	8	125 / 160 x 150	5	5650

Shouldered Adaptor

073206

Raccord à emboîture épaulée
Adaptador minero

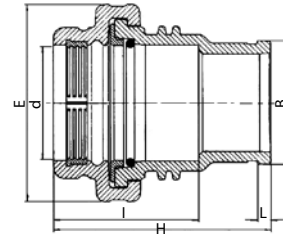

Size d x DN (inch)	E	H	I	L	B	UB	UC	W
160 x 150 (6")	280	304	204	17.5	175	—	4	5404

Metal Flange

17006

Bride de métal
Brida de metal

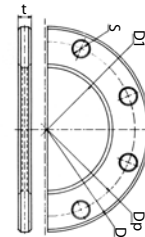

Size d x DN (inch)	D	Dp	D1	S	t	Th**		No. of Holes	W
						mm	inch		
125 / 160 x 125 (5")	250	210	170	18	12	M16	5/8	8	1100
125 / 160 x 150 (6")	250	240	170	22	12	M20	3/4	8	1800

** Nominal diameter of bolts
** Diamètre nominal de l'écrou
** Diametro nominal del tornillo

Saddle Single Outlet with Reinforcing Ring Options

16076/16086/16279/16079*

For more details, see table on page 71, 72, 73

Collier de prise simple avec bague de renforcement
Collarin simple con anillo de refuerzo

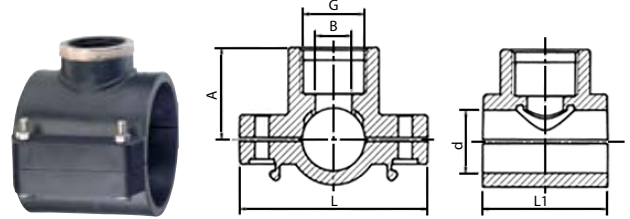

Size d x G	B	L	L1	A	No. of Bolts	UB	UC	W
20 x 1/2"	10	70	45	33	2	1	400	62
25 x 1/2"	15	75	50	36	2	1	300	70
25 x 3/4"	15	75	50	37	2	1	300	73
32 x 1/2"	16	92	60	40	2	1	150	133
32 x 3/4"	19	92	60	41	2	1	150	135
32 x 1"	19	92	60	42	2	1	150	142
40 x 1/2"	16	92	60	46	2	1	150	141
40 x 3/4"	19	92	60	46	2	1	150	143
40 x 1"	25	92	60	49	2	1	150	151
50 x 1/2"	16	106	73	51	2	1	100	178
50 x 3/4"	21	106	73	52	2	1	100	180
50 x 1"	25	106	73	54	2	1	100	187
50 x 1 1/4"	25	106	73	58	2	1	100	212
63 x 1/2"	16	116	84	58	4	1	70	277
63 x 3/4"	20	116	84	59	4	1	70	280
63 x 1"	25	116	84	61	4	1	70	286
63 x 1 1/4"	32	116	84	66	4	1	70	308
63 x 1 1/2"	39	116	84	67	4	1	60	322
75 x 1/2"	16	122	98	64	4	1	60	369
75 x 3/4"	20	122	98	65	4	1	55	369
75 x 1"	25	122	98	67	4	1	55	376
75 x 1 1/4"	32	122	98	72	4	1	55	398
75 x 1 1/2"	40	122	98	73	4	1	50	411
75 x 2"	40	122	98	78	4	1	50	433
90 x 1/2"	16	141	105	72	4	1	45	453
90 x 3/4"	20	141	105	73	4	1	45	454
90 x 1"	25	141	105	75	4	1	45	460
90 x 1 1/4"	32	141	105	80	4	1	40	482
90 x 1 1/2"	40	141	105	81	4	1	40	493
90 x 2"	50	141	105	86	4	1	40	511
110 x 1/2"	16	165	116	83	4	1	45	561
110 x 3/4"	20	165	116	84	4	1	45	562
110 x 1"	25	165	116	87	4	1	36	566
110 x 1 1/4"	32	165	116	91	4	1	36	588
110 x 1 1/2"	40	165	116	92	4	1	36	600
110 x 2"	50	165	116	97	4	1	30	615
125 x 3/4"	20	184	124	91	6	1	30	749
125 x 1"	25	184	124	94	6	1	30	754
125 x 1 1/4"	32	184	124	98	6	1	30	779
125 x 1 1/2"	40	184	124	99	6	1	30	781
125 x 2"	50	184	124	104	6	1	30	796
140 x 1"	25	201	136	101	6	1	24	893
140 x 1 1/4"	32	201	136	106	6	1	24	912
140 x 1 1/2"	40	201	136	107	6	1	24	922
140 x 2"	50	201	136	112	6	1	20	938
160 x 1"	25	223	145	116	6	1	20	1039
160 x 1 1/4"	32	223	145	117	6	1	20	1061
160 x 1 1/2"	40	223	145	118	6	1	20	1071
160 x 2"	50	223	145	123	6	1	20	1080
180 x 1"	25	245	154	122	6	1	16	1300
180 x 1 1/4"	32	245	154	127	6	1	16	1319
180 x 1 1/2"	40	245	154	128	6	1	16	1327
180 x 2"	50	245	154	133	6	1	16	1334

* stainless steel nuts & bolts

Saddle Double Outlet with Reinforcing Ring Options

Collier de prise double avec bague de renforcement
Collarin doble con anillo de refuerzo

16176/16186 /16179*

For more details, see table on page 71, 72, 73

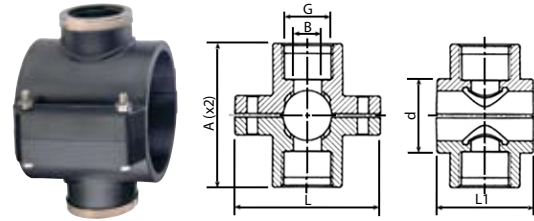

Size d x G	B	L	L1	A	No. of Bolts	UB	UC	W
20 x 1/2"	10	70	45	66	2	1	300	73
25 x 1/2"	15	75	50	71	2	1	250	81
25 x 3/4"	15	75	50	73	2	1	250	86
32 x 1/2"	16	92	60	80	2	1	140	145
32 x 3/4"	19	92	60	82	2	1	140	148
32 x 1"	19	92	60	84	2	1	147	163
40 x 1/2"	16	92	60	89	2	1	120	154
40 x 3/4"	19	92	60	91	2	1	120	158
40 x 1"	25	92	60	98	2	1	120	174
50 x 1/2"	16	106	73	102	2	1	80	193
50 x 3/4"	21	106	73	104	2	1	80	196
50 x 1"	25	106	73	109	2	1	80	210
50 x 1 1/4"	25	106	73	117	2	1	80	260
63 x 1/2"	16	116	84	116	4	1	80	293
63 x 3/4"	20	116	84	118	4	1	80	297
63 x 1"	25	116	84	123	4	1	70	310
63 x 1 1/4"	32	116	84	132	4	1	60	355
63 x 1 1/2"	39	116	84	133	4	1	60	382
75 x 1/2"	16	122	98	128	4	1	60	382
75 x 3/4"	20	122	98	130	4	1	60	382
75 x 1"	25	122	98	135	4	1	50	396
75 x 1 1/4"	32	122	98	144	4	1	50	439
75 x 1 1/2"	40	122	98	145	4	1	50	465
75 x 2"	40	122	98	155	4	1	40	513
90 x 1/2"	16	141	105	143	4	1	45	467
90 x 3/4"	20	141	105	146	4	1	45	469
90 x 1"	25	141	105	151	4	1	45	481
90 x 1 1/4"	32	141	105	160	4	1	40	526
90 x 1 1/2"	40	141	105	162	4	1	40	547
90 x 2"	50	141	105	172	4	1	36	585
110 x 1/2"	16	165	116	166	4	1	40	575
110 x 3/4"	20	165	116	168	4	1	40	577
110 x 1"	25	165	116	173	4	1	40	587
110 x 1 1/4"	32	165	116	182	4	1	30	629
110 x 1 1/2"	40	165	116	187	4	1	30	654
110 x 2"	50	165	116	196	4	1	30	684
125 x 3/4"	20	184	124	182	6	1	30	769
125 x 1"	25	184	124	187	6	1	30	777
125 x 1 1/4"	32	184	124	196	6	1	20	814
125 x 1 1/2"	40	184	124	198	6	1	20	834
125 x 2"	50	184	124	208	6	1	20	861
140 x 1"	25	201	136	202	6	1	20	908
140 x 1 1/4"	32	201	136	212	6	1	20	947
140 x 1 1/2"	40	201	136	213	6	1	20	967
140 x 2"	50	201	136	223	6	1	20	1001
160 x 1"	25	223	145	223	6	1	16	1055
160 x 1 1/4"	32	223	145	233	6	1	16	1098
160 x 1 1/2"	40	223	145	235	6	1	16	1119
160 x 2"	50	223	145	245	6	1	16	1137
180 x 1"	25	245	154	243	6	1	16	1310
180 x 1 1/4"	32	245	154	253	6	1	16	1335
180 x 1 1/2"	40	245	154	255	6	1	16	1349
180 x 2"	50	245	154	265	6	1	16	1368

* stainless steel nuts & bolts

Plated Nut & Bolt for Saddles

16005*

Visse et écrou pour colliers en acier galvanisé
Tornillo y tuerca de acero niquelado para collarín



Bolts Dimensions/mm	Saddles
6 x 30	20 - 25
8 x 45	32 - 40 - 50 - 63
8 x 60	75 - 90 - 110
8 x 70	125 - 140 - 160

- * Nuts & Bolts also available in stainless steel
- * Boulons et écrous disponibles aussi en acier inoxydable
- * Tornillos y tuercas, a disposición, en acero inoxidable

O - Rings For Saddles (Refer to page 48-49)

070020

Joints toriques pour colliers (voir page 48-49)
Juntas tóricas para collarín (ver página 48-49)

O - Ring Dimensions/mm	Saddles
**13.95 x 2.62	20 - 1/2"
**16.72 x 2.62	1/2", 25 - 3/4"
**25.80 x 3.53	1/2", 32 - 3/4", 32 - 1"
*24.00 x 4.00	1/2", 40 - 3/4"
*31.00 x 5.00	1", 50 - 1/2", 50 - 3/4", 50 - 1", 50 - 1 1/4", 63 - 1/2", 63 - 3/4", 63 - 1", 75 - 1/2", 75 - 3/4", 75 - 1", 90 - 1/2", 90 - 3/4", 90 - 1", 110 - 1/2", 110 - 3/4", 110 - 1", 125 - 3/4", 125 - 1", 140 - 1", 160 - 1"
*39.00 x 6.00	63 - 1 1/4", 75 - 1 1/4", 90 - 1 1/4", 110 - 1 1/4", 125 - 1 1/4", 140 - 1 1/4", 160 - 1 1/4"
*49.00 x 7.00	63 - 1 1/2", 75 - 1 1/2", 75 - 2", 90 - 1 1/2", 110 - 1 1/2", 125 - 1 1/2", 140 - 1 1/2", 160 - 1 1/2"
*62.00 x 7.00	90 - 2", 110 - 2", 125 - 2", 140 - 2", 160 - 2",

- * The NBR O-Ring can be replaced by O-Ring of FPM or EPDM
- * La bague NBR peut être remplacée par une bague FPM ou EPDM
- * Las juntas tóricas de NBR (nitrilo) pueden ser remplazadas por juntas tóricas de FPM (fluoropolimero) o EPDM
- ** Family code 07002P
- ** Code de la Famille 07002P
- ** Familia del producto 07002P

Compression Saddle

16810

Collier à compression
Collarín simple de compresión

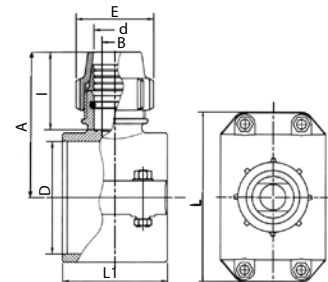

Size D x d	I	L1	L	A	E	B	No. of Bolts	UB	UC	W
90 x 50	10	70	45	66	66	66	2	1	300	73
110 x 50	15	75	50	71	71	71	2	1	250	81
140 x 50	15	75	50	73	73	73	2	1	250	86
160 x 50	16	92	60	80	80	80	2	1	140	145

Mechanical Tapping Valve

Prise de branchement mecanique avec robinet
Valvula mecanica con salida rotatoria taper

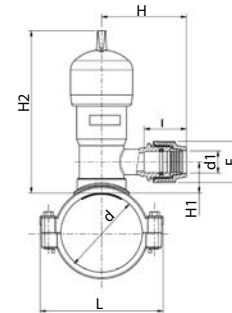
18680

Size d x D1	L	L1*	H	H1	H2	E	I	UB	UC	W
63 x 32	116	48	135	48	248	64	67	1	8	2090
63 x 63	116	48	200	53	248	113	110	1	8	2210
75 x 32	122	98	135	48	248	64	67	1	8	1840
75 x 63	122	98	200	53	248	113	110	1	8	2230
90 x 32	141	105	135	48	248	64	67	1	8	2150
90 x 63	141	105	200	53	248	113	110	1	8	2270
110 x 32	165	116	135	48	248	64	67	1	10	2270
110 x 63	165	116	200	53	248	113	110	1	8	2730
125 x 32	184	124	135	48	248	64	67	1	8	2280
125 x 63	184	124	200	53	248	113	110	1	8	2390
140 x 32	201	136	135	48	248	64	67	1	8	2290
140 x 63	201	136	200	53	248	113	110	1	6	2440
160 x 32	223	145	135	48	248	64	67	1	6	2380
160 x 63	223	145	200	53	248	113	110	1	6	2490
180 x 32	245	154	135	48	248	64	67	1	6	2440
180 x 63	245	154	200	53	248	113	110	1	4	2550

* L1 - Length along pipe * L1 - Longitud del collarin * L1 - longueur de la prise de branchement

Tapper - for PVC & PE Pipes

Prise de branchement Tapper® pour tube PVC et PE
Collarin con salida rotatoria Tapper® para tubos de PVC y de PE

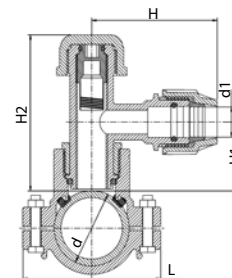
16540

Size D x Dn	H	L	L1*	H1	H2	No. of Bolts	UB	UC	W
63 x 25	106	116	84	57	130	4	1	40	584
63 x 32	111	116	84	57	130	4	1	40	614
75 x 25	106	122	98	57	130	4	1	30	700
75 x 32	111	122	98	57	130	4	1	30	725
90 x 25	106	141	105	58	131	4	1	25	761
90 x 32	111	141	105	58	131	4	1	25	781
110 x 25	106	165	116	59	132	4	1	20	872
110 x 32	111	165	116	59	132	4	1	20	902
125 x 25	106	184	124	58	131	6	1	16	1058
125 x 32	111	184	124	58	131	6	1	16	1088
140 x 25	106	201	136	59	132	6	1	14	1228
140 x 32	111	201	136	59	132	6	1	14	1228
160 x 25	106	223	145	59	132	6	1	10	1344
160 x 32	111	223	145	59	132	6	1	10	1374
180 x 25	106	245	154	60	133	6	1	8	1606
180 x 32	111	245	154	60	133	6	1	8	1640

* L1 - Length along pipe * L1 - Longitud del collarin * L1 - longueur de la prise de branchement

Tapper® - Brass Cutter for PVC & PE Pipes (including O-Ring)

165400012

Couteau pour PVC (avec joint torique)
Cortatubo para tubos de PVC (con junta tórica)

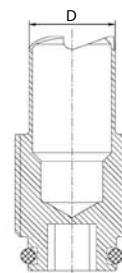

Size d	A	UB	UC	W
63 x 180mm	20	—	—	94

Saddle Seal for Tapper® (EPDM)

16532

Joint pour Tapper® (EPDM)
Sello de collarín Tapper® (EPDM)

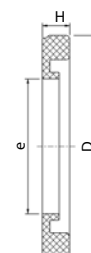

Size One Size	e	D	H	UB	UC	W
63 x 180mm	36.5	60	7	—	—	12

Stainless Steel Nuts & Bolts for Saddles

16007

Visse et écrou pour colliers en acier inoxydable
Tuercas y tornillos en acero inoxidable para collarín



Bolts Dimensions/mm	Saddles
8 x 45	63
8 x 60	75 - 90 - 110
8 x 70	125 - 140 - 160 - 180

Threaded Socket

Manchon fileté femelle
Manguito rosca hembra x hembra

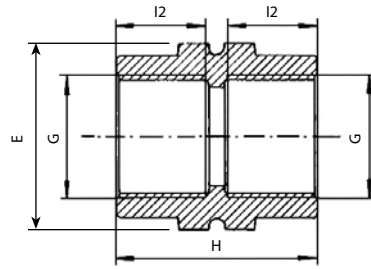
050107*

Size G x G	H	I2	E	UB	UC	W
1/2" x 1/2"	39	17	30	10	1200	15
3/4" x 3/4"	41	19	36	10	1000	20
1" x 1"	45	21	46	10	600	31
1 1/4" x 1 1/4"	54	25	60	10	250	65
1 1/2" x 1 1/2"	54	25	65	10	250	75
2" x 2"	65	30	75	5	150	92

* With reinforcing ring - Cat. No. 050117

* Avec bague d'acier sans étain 050117

* Con anillo de refuerzo - Cat. No. 050117

Threaded Reducing Bushing

Manchon fileté femelle
Manguito reductor hembra x macho

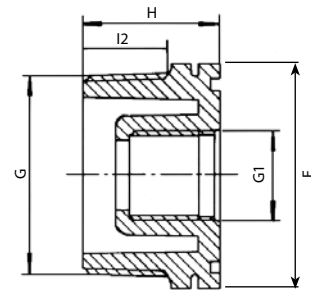
050207

Size G x G1	H	I2	E	UB	UC	W
3/4" x 1/2"	30	17	27	10	2000	7
1" x 1/2"	32	19	36	10	1200	16
1" x 3/4"	32	19	36	10	1000	11
1 1/4" x 1/2"	37	21	46	10	700	27
1 1/4" x 3/4"	37	21	46	10	700	29
1 1/4" x 1"	37	21	46	10	700	21
1 1/2" x 1/2"	37	21	50	10	600	35
1 1/2" x 3/4"	37	21	50	10	600	32
1 1/2" x 1"	37	21	50	10	500	33
1 1/2" x 1 1/4"	37	21	50	10	500	20
2" x 1/2"	41	25	63	5	350	58
2" x 3/4"	41	25	63	5	350	60
2" x 1"	41	26	63	5	350	61
2" x 1 1/4"	41	26	63	5	320	55
2" x 1 1/2"	41	26	63	5	320	44
2" x 2"	44	29	80	5	200	75
3" x 1"	48	33	90	2	150	117
3" x 1 1/4"	48	33	90	2	150	119
3" x 1 1/2"	48	33	90	2	150	118
3" x 2"	48	33	90	2	150	103
3" x 2 1/2"	48	33	90	2	150	76
4" x 2"	56	41	120	2	80	238
4" x 3"	56	41	120	2	80	222

90° Threaded Tee

050407*

Té à 90° fileté femelle
Te de 90° rosca hembra

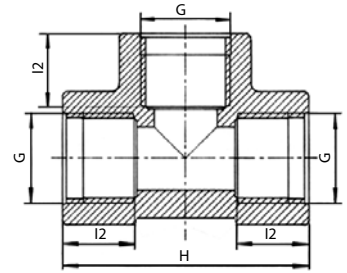

Size G	H	I2	UB	UC	W
1/2"	58	17	10	700	28
3/4"	64	18	10	500	39
1"	81	21	10	260	61
1 1/4"	96	25	5	140	114
1 1/2"	108	25	5	90	157
2"	130	30	5	60	205

* With reinforcing ring - Cat. No. 050417
 * Avec bague d'acier sans étain 050417
 * Con anillo de refuerzo - Cat. No. 050417

90° Threaded Elbow

050507*

Coude à 90° fileté femelle
Codo de 90° rosca hembra

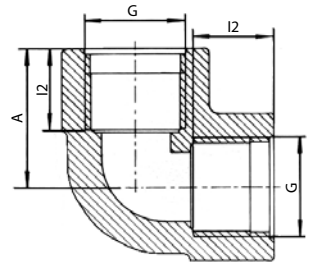

Size G x G	A	I2	UB	UC	W
1/2" x 1/2"	29	17	10	1000	22
3/4" x 3/4"	32	18	10	700	31
1" x 1"	41	21	10	400	45
1 1/4" x 1 1/4"	48	25	10	200	87
1 1/2" x 1 1/2"	54	25	5	150	116
2" x 2"	65	30	5	80	157

* With reinforcing ring - Cat. No. 050517
 * Avec bague d'acier sans étain 050517
 * Con anillo de refuerzo - Cat. No. 050517

90° Threaded Elbow Male x Female

051507

Coude de transition-fileté mâle x femelle
Codo roscado-macho x hembra

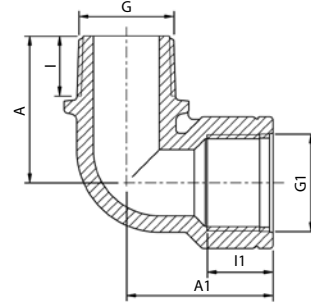

Size G x G1	A	A1	I	I1	UB	UC	W
1/2" x 1/2"	36	36	15.5	17	10	1000	17
3/4" x 3/4"	40	40	16.5	18	10	700	25
1" x 1"	45	47	18.5	21	10	400	40

Threaded Reducing Nipple

050605

Mamelon de réduction fileté
Machón doble reductor

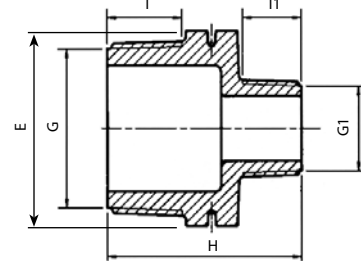

Size G x G1	A	A1	I	I1	UB	UC	W
3/4" x 1/2"	46.5	16.5	15.5	27	10	1500	10
1" x 1/2"	48.5	18.5	15.5	36	10	800	17
1" x 3/4"	49.5	18.5	16.5	36	10	800	18
1 1/4" x 1/2"	53	21	15.5	46	10	500	28
1 1/4" x 3/4"	54	21	16.5	46	10	500	29
1 1/4" x 1"	56	21	18.5	46	10	500	31
1 1/2" x 1/2"	54	21	15.5	50	5	500	35
1 1/2" x 3/4"	55	21	16.5	50	5	500	34
1 1/2" x 1"	57	21	18.5	50	5	400	37
1 1/2" x 1 1/4"	59	21	21	50	5	400	40
2" x 1/2"	57.5	25	15.5	63	5	280	51
2" x 3/4"	58.5	25	16.5	63	5	260	52
2" x 1"	60.5	25	18.5	63	5	260	54
2" x 1 1/4"	63	25	21	63	5	240	58
2" x 1 1/2"	63	25	21	63	5	240	59

Threaded Nipple

050607

Mamelon double fileté
Machón doble

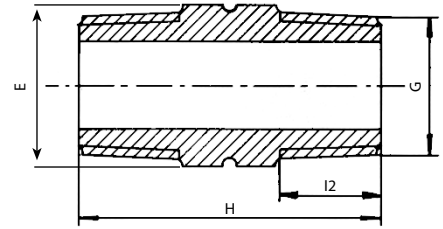

Size G x G	H	I2	E	UB	UC	W
1/2" x 1/2"	48	15	22	10	2000	8
3/4" x 3/4"	50	17	27	10	1500	12
1" x 1"	55	19	36	10	800	23
1 1/4" x 1 1/4"	60	22	46	10	400	35
1 1/2" x 1 1/2"	61	22	50	5	300	48
2" x 2"	71	26	65	5	180	78

Threaded Cap

050707

Mamelon double fileté
Machón doble

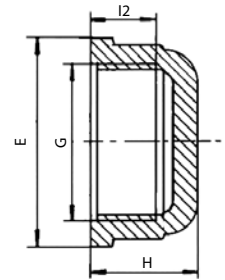

Size G	E	H	I2	UB	UC	W
1/2"	37	25	14.5	10	1600	13
3/4"	41.5	26	16	10	1500	14
1"	49.5	31.5	19	10	800	27
1 1/4"	59	34	21.5	10	500	39
1 1/2"	64.5	34	21	10	450	43
2"	80	39	25	5	250	78

Threaded Reducing Socket

051107

Manchon de réduction fileté femelle
Manguito reductor rosca hembra - hembra

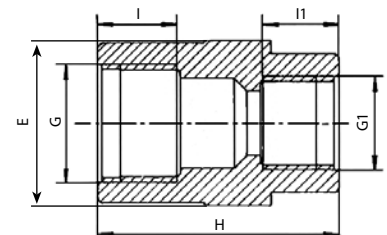

Size G x G1	H	I	I1	E	UB	UC	W
3/4" x 1/2"	54	20	18	36	10	800	25

Threaded Riser

051607

Rallonge fileté
Espiga roscada

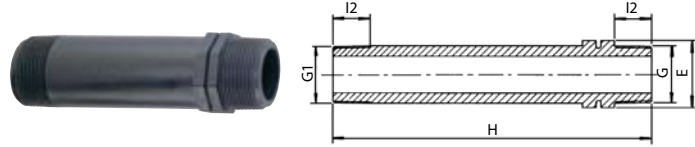

Size G x G	H	I2	E	UB	UC	W
1/2" x 1/2"	150	17.5	22	10	600	30
3/4" x 1/2"	112.5	17.5	27	10	500	26
3/4" x 3/4"	150	17.5	27	10	400	44
1" x 1"	150	20	36	5	250	66
1 1/4" x 1 1/4"	150	22	46	5	150	93
1 1/2" x 1 1/4"	150	22	50	5	140	115
1 1/2" x 1 1/2"	150	22	50	5	140	120

Threaded Plug

051707

Bouchon fileté
Tapón rosca macho

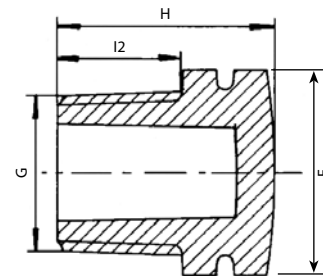

Size G	H	I2	E	UB	UC	W
3/8"	24	13	22	10	4500	5
1/2"	29	16	27	10	2500	8
3/4"	31	17	32	10	1500	12
1"	34	19	36	10	1000	17
1 1/4"	38	22	46	10	700	26
1 1/2"	39	22	55	10	500	38
2"	45	26	65	10	300	60

Threaded Stoptap

(Seal NBR)

Robinet à soupape droite (joint NBR)
Válvula de línea rosca hembra (juntas NBR)

03405

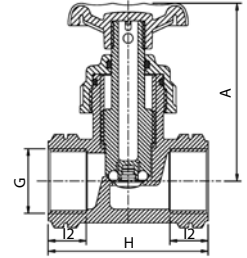

Size G x G	H	I2	A	UB	UC	W
3/4" x 3/4"	78	18	92	5	140	115
1" x 1"	82	20	92	5	120	129

Compression Stoptap

(Seal NBR)

Robinet à soupape droite, embouts compression (joint NBR)
Válvula de línea compresión (juntas NBR)

03407

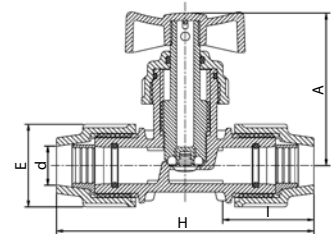

Size G x G1	E	H	I	A	UB	UC	W
20 x 20	48	147	58	101	5	100	160
25 x 25	54	157	60	91	5	80	190
32 x 32	64	163	70	95	5	60	250

Angle Seat Valve

(Seal NBR) Threaded x Compression

03048/03948*

Robinet à soupape oblique, embouts filetés/compression (joint torique NBR)
Válvula de asiento angular - compresión - rosca macho - juntas NBR

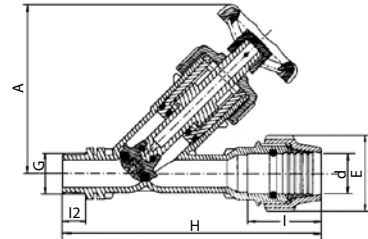

Size G x G	E	H	I	I2	A	UB	UC	W
20 x 1/2"	48	172	58	16	—	113	100	176
25 x 3/4"	54	187	60	18	—	121	80	238
32 x 1"	64	212	70	20	—	140	50	360
40 x 1 1/4"*	82	258	86	22	—	180	26	618
50 x 1 1/2"*	96	296	98	22	—	207	17	939
63 x 2"*	113	338	112	26	—	246	10	1518

Angle Seat Valve

(Seal NBR) Threaded Inlet & Outlet

03047*

Robinet à soupape oblique, (joint NBR) embouts filetés
Válvula de asiento angular, (sello NBR) roscas macho

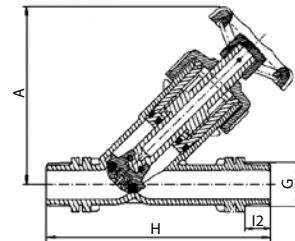

Size G x G	H	I2	A	UB	UC	W
1/2" x 1/2"	134	16	113	5	120	136
3/4" x 3/4"	151	18	121	5	100	191
1" x 1"	170	20	140	—	70	280
1 1/4" x 1 1/4"	200	22	180	—	40	474
1 1/2" x 1 1/2"	225	22	207	—	24	733
2" x 2"	254	26	246	—	15	1208

* Available with NPT thread

* Disponible fileté NPT

* Disponible con rosca NPT

Angle Seat Valve

(Seal FPM) Threaded Inlet & Outlet

Robinet à soupape oblique, (joint FPM) embouts filetés
Válvula de asiento angular, (sello FPM) roscas macho

03049*

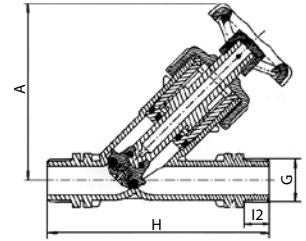

Size G x G	H	I2	A	UB	UC	W
1/2" x 1/2"	134	16	113	5	120	136
3/4" x 3/4"	151	18	121	5	100	191
1" x 1"	170	20	140	—	70	280
1 1/4" x 1 1/4"	200	22	180	—	40	474
1 1/2" x 1 1/2"	225	22	207	—	24	733
2" x 2"	254	26	246	—	15	1186

- * Available with NPT thread
- * Disponible fileté NPT
- * Disponible con rosca NPT

Angle Seat Valve

(Seal NBR) Compression Inlet & Outlet

Robinet à soupape oblique, (joint NBR) Embouts compression
Válvula de asiento angular, (sello NBR) compresión

03046

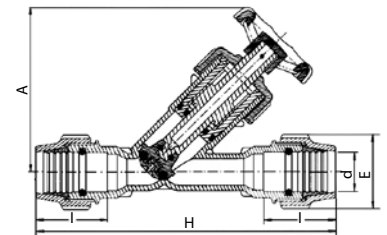

Size d x d	E	H	I	A	UB	UC	W
32 x 32	64	254	70	140	—	40	438

Check Valve

03067*

(Seal EPDM) Threaded Inlet & Outlet

Soupape de retenue, (joint EPDM) embouts filetés
Válvula antirretorno, (sello EPDM) roscas macho

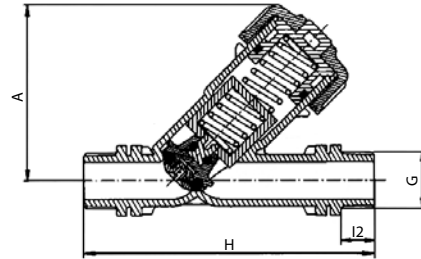

Size G	H	I2	A	UB	UC	W
3/4" x 3/4"	151	18	96	5	140	141
1" x 1"	170	20	106	5	100	229
1 1/4" x 1 1/4"	200	22	134	—	55	382
1 1/2" x 1 1/2"	225	22	155	—	35	586
2" x 2"	254	26	182	—	20	975

* Available with NPT thread

* Disponible fileté NPT

* Disponible con rosca NPT

Quick Coupling Valve

03039

(Seal NBR)

Clapet vanne démontable (joint NBR)
Válvula de acople rápido (juntas NBR)

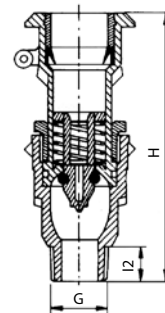

Size G	H	I2	UB	UC	W
3/4"	146	17	5	130	144
1"	148	18	5	130	148

Key

03139

for Quick Coupling Valve 3039

Branchement pour clapet vanne 3039
Conexión de acople rápido

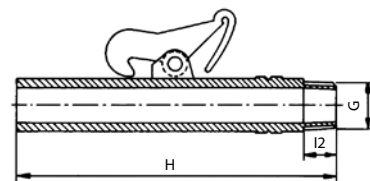

Size G	H	I2	UB	UC	W
3/4"	173	18	5	250	66

Check Valve Insert

Soupape de retenue
Válvula de antirretorno

03226

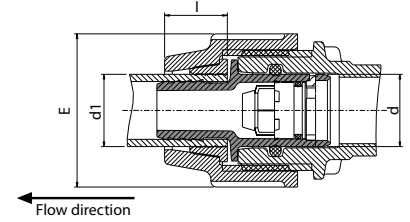

Size d x d1	E	I	UB	UC	W
25 x 25	63	22	—	—	—

Check Valve Insert

Soupape de retenue
Válvula de antirretorno

03227

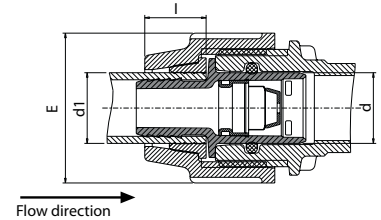

Size d x d1	E	I	UB	UC	W
25 x 25	63	22	—	—	—

BSPT Record for Water Meter

Adaptateur pour compteur d'eau D'EAU
Tubo y tuerca BSPT

3589

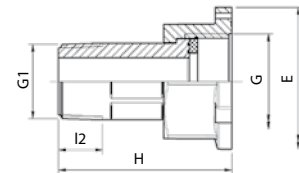

Size G x G1	E	H	I2	UB	UC	W
3/4" x 1/2"	44	56	15.5	—	—	—
1" x 3/4"	52	61	15.5	—	—	—

Water Meter Manifold

Rail de compteur à eau
Soporte para control de flujo de agua

03510

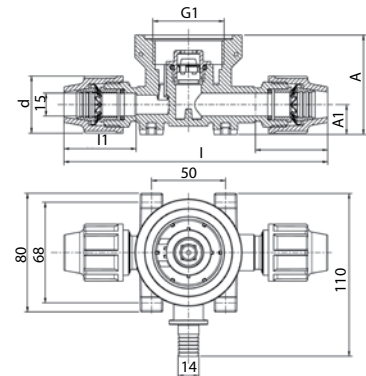

Size d x G1 x d	I	I1	A	A1	UB	UC	W
15 x 1 1/2" x 15	178	49	67	20	—	—	—

Quarter Turn Valve

03010

Male Threaded x Compression

Robinet un quart de tour male filetee / compression
Rosca Macho/ Compresión

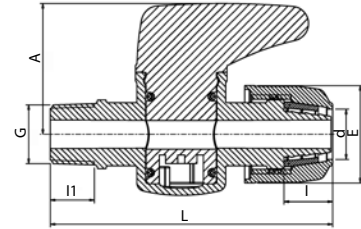
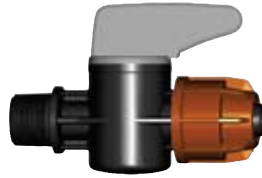

Size d x G	L	A	E	I	I1	UB	UC	W
16 x 1/2"	97	46	34	17	15	10	450	53
16 x 3/4"	99	46	34	17	17	10	400	74

Quarter Turn Valve

03011

Female Threaded x Compression

Robinet un quart de tour femelle filetee / compression
Rosca Hembra/ Compresión

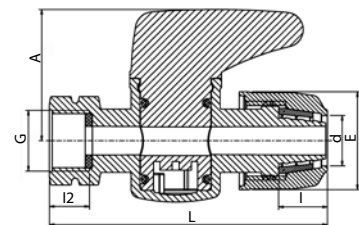
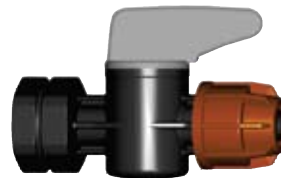

Size d x G	L	A	E	I	I1	UB	UC	W
16 x 1/2"	99	46	34	17	15	10	400	55
16 x 3/4"	102	46	34	17	17	10	350	76

Quarter Turn Valve

03012

Male Threaded x Female Threaded

Robinet un quart de tour male filete / femelle filetee
Rosca Macho-/Rosca Hembra

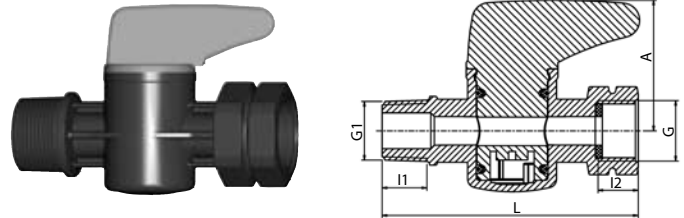

Size G1 x G	L	A	I1	I2	UB	UC	W
1/2" x 1/2"	89	46	15	14	10	500	47
3/4" x 3/4"	97	46	17	18	10	400	

Quarter Turn Valve

03013

Flex Hose x Female Threaded

Robinet un quart de tour pour tuyau souple / femelle filetee
Mangera Flexible/Rosca Hembra

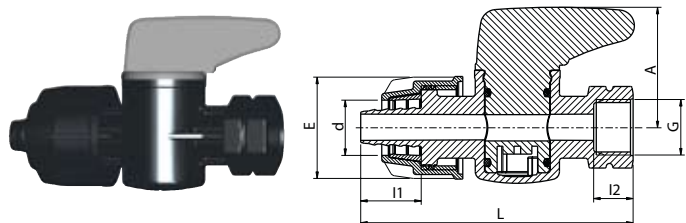

Size d x G	L	A	E	I1	I2	UB	UC	W
1/2" x 1/2"	103	44	39	23	14	10	400	56
1/2" x 3/4"	109	44	39	23	18	—	—	—

Quarter Turn Valve

03016

Barbed x Female Threaded

Robinet un quart de tour tranchante / femelle filetee
Afilado Roscado-Rosca Hembra

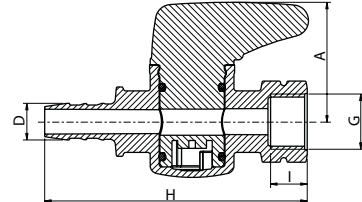
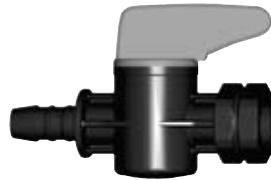

Size D x G	L	A	I2	UB	UC	W
1/2" x 1/2"	100	44	14	10	450	45

Quarter Turn Valve

03017

Compression x Compression

Robinet un quart de tour embouts compression
Compresion

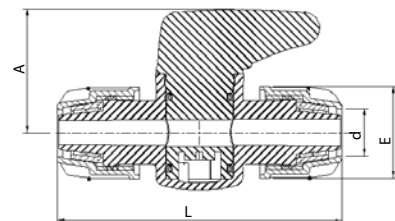
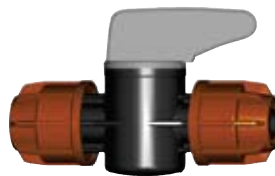

Size d x d	L	A	E	I1	UB	UC	W
16 x 16	106	46	34	17	10	300	—

Quarter Turn Valve

03019

Garden Hose Male Thread x Female Threaded

Robinet un quart de tour pour tuyau de jardin male filetee/femelle filetee
Rosca Macho Mangera de Jardin/Rosca Hembra

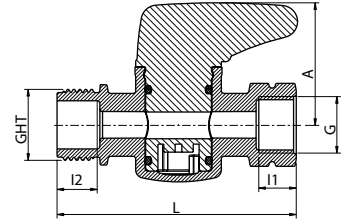

Size GHT x G	L	A	I1	I2	UB	UC	W
GHT x 1/2"	90	44	14	14	10	500	47

Quarter Turn Valve

03020

Male Thread x Barbed

Robinet un quart de tour male filete / tranchante
Rosca Macho-Afilado Roscado

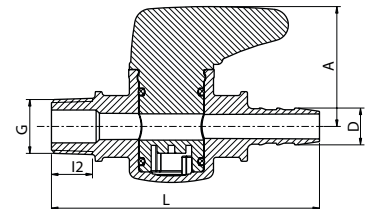

Size GHT x G	L	A	I1	I2	UB	UC	W
1/2" x 1/2"	102	44					

Technical Data



Materials

Compression Fittings

Body: Polypropylene, high-grade copolymer.

Nut: Polypropylene, high-grade copolymer.

Split Ring: Acetal (POM, CPVC also available).

Liner: Acetal (POM).

Seal: Nitrile rubber (NBR, EPDM, FPM also available).

Reinforcing ring: Stainless steel on all female offtakes from 1 1/4" up to 4".

Bolts (Series 17): Plated steel.

Nuts (Series 17): Stainless steel.

Valves

Body: Polypropylene, high-grade copolymer.

O-Ring: See inside.

Spring: (items 03067, 03039), Stainless steel.

Saddles

Body: Polypropylene, high-grade copolymer.

Bolts and Nuts: Plated steel. (Stainless steel bolts and nuts also available)

Reinforcing Rings: Stainless steel.

Seal: Nitrile rubber (NBR).

Tappers + Compression Saddles

Body: Polypropylene, high-grade copolymer.

Split Rings: Acetal (POM, CPVC also available).

Nuts: Polypropylene, high-grade copolymer.

Bolts and Nuts: Stainless Steel.

Seal: EPDM.

Threaded Fittings

Body: Polypropylene, high-grade copolymer.

Reinforcing Ring: Stainless Steel.

Operating Temperatures

The fittings and valves are not to be used with hot water, although they withstand the same temperature as the polyethylene pipe itself. The fittings and valves will withstand sub-zero temperatures.

Chemical Resistance

Plasson Fittings are supplied, as standard, with polyacetal split rings and NBR O-rings which are suitable for water. For aggressive chemical applications CPVC split rings and EPDM or FPM O-rings can be supplied to produce a better chemical resistance.

Operating Pressures and Quality Certificates

Plasson Fittings are tested and approved according to ISO14236 and AS/NZ 4129. For detailed pressure classification see page 71.

Threads

All threads conform to ISO-7/1, BS 21 - 1973, DIN 2999, NEN 3258, AS 1722 Part 1 - 1975.

All internal (female) threads smaller than 3" are parallel.

All other threads (male and female) are tapered.

Flanges

Flange dimensions in accordance with: ISO 7005-1 (TABLE 11), BS 4504: 1989 (TABLE 11), DIN 2501 (PN 16 TABLE), AS/NZS 4331. Metal backing rings to be used with all flanges.

Legend

UB	Units per bag
UC	Units per carton
W	Weight in grams

Note

Before installation ensure that the end of the pipe to be inserted into the fitting is free of scratches and other imperfections and that both the pipe and the fitting itself are clean of sand, mud, stones etc.

Do not over tighten nut when closing. Never use wrenches or spanners with handle lengths longer than 46 cm - excessive torque during tightening can spread nut cone and result in pull outs.

If fittings are reused, ensure split ring is sharp and bites into pipe to avoid pull outs. Alternatively replace split ring.

Note: We strongly recommend the use of PTFE tape in threaded connections.

Matériaux

Raccords à compression

Corps: Polypropylène, copolymère de haute qualité.

Ecrou: Polypropylène, copolymère de haute qualité.

Bague de crampage: Acétal (POM, disponible aussi en CPVC).

Joint torique: Caoutchouc nitrile (NBR, EPDM, FPM aussi disponibles).

Bague de renforcement: Acier inoxydable sur tous les raccords femelles de 1 1/4" à 4".

Boulons (Série 17): Acier galvanisé.

Ecrous (Série 17): Acier inoxydable.

Vannes

Corps: Polypropylène, copolymère de haute qualité.

Joint torique: NBR-FPM ou EPDM selon l'article.

Ressort: (éléments 03067, 03039), Acier inoxydable.

Colliers de prise en charge

Corps: Polypropylène, spécialement stabilisé pour résister à une exposition continue aux agents atmosphériques.

Visses et écrous: Acier galvanisé.

(Visses et écrous en acier inoxydable également disponibles sur demande et avec majoration de prix). Bagues de renforcement: Acier inoxydable.

Joint: NBR.

Tapper + Colliers à compression

Corps: Polypropylène, noir spécialement stabilisé pour résister à une exposition continue aux agents atmosphériques. Bagues de crampage: Acétal (POM).

Ecrous: Polypropylène, copolymère de forte teneur.

Boulons et écrous: Acier inoxydable.

Joint: EPDM.

Raccords filetés

Corps: Polypropylène, copolymère de haute qualité.

Bagues de renforcement: Acier inoxydable.

Températures de Service

Les raccords, les robinets et les colliers ne sont pas faits pour une utilisation avec de l'eau chaude. Toutefois, ils supportent les mêmes températures que le tube en polyéthylène et les températures inférieures à 0°C.

Résistance Chimique

Les raccords **Plasson** sont équipés de façon standard d'une bague de crampage en acétal et d'un joint torique NBR adaptés à l'application en eau.

Pour les applications industrielles avec transport de fluides chimiques agressifs, il est recommandé d'utiliser une bague de crampage qui assure une meilleure résistance chimique.

Pressions de Service et Attestations de Qualité

Les raccords **Plasson** sont testés et certifiés selon les normes ISO 14236 et AS/NZ 4129. Pour connaître la pression nominale de chaque article, se référer à la page 72.

Filetages

Toutes les pièces filetés sont fabriqués selon les normes ISO-7, BS 21 - 1973, DIN 2999, NEN 3258, AS 1722 Part 1 - 1975.

Tous les filetés femelles plus petits que 3" sont parallèles. Tous les autres filetés (males et femelles) sont éfilés.

Brides

Les dimensions des brides sont conformes à: ISO 7005-1 (TABLE 11), BS 4504:1989 (TABLE 11), DIN 2501 (PN 16 TABLE), AS/NZS 4331.

Bride de métal à utiliser avec toutes les brides.

Legend

UB	Quantité par sac
UC	Quantité par carton
W	Poids en grammes

Remarque

Avant d'installer, assurez-vous:

Que le bout du tube à introduire est net de toutes éraflures ou de toutes autres imperfections. Que le tube et le raccord sont propres de sable, boue, pierres, etc.

De ne pas trop serrer l'écrou. N'utilisez pas de clefs ayant un manche dépassant 46cm – un mouvement de torsion excessif pendant le serrage peut aplanir l'écrou et aboutir à des tractions. Pour éviter toutes tractions et dans tous les cas où le raccord est réutilisé, il faut vérifier que la bague de crampage est tranchante et qu'elle mords bien dans le tuyau. Sinon, changez la bague de crampage.

Remarque: Nous recommandons fortement l'utilisation d'un ruban PTFE, dans les connections filetés

Materiales

— **Accesorios de compresión** —
Cuerpo: Polipropileno, block copolímero de alta calidad.
Racor: Polipropileno, block copolímero de alta calidad.
Casquillo de apriete: Acetal (POM).
 Disponibles también en PVC-C.
 Refuerzo interno de tubos: Acetal (POM).
Junta tórica: Nitrilo (NBR). disponibles también en EPDM y FPM
Anillo de refuerzo: Acero inoxidable en todas las tomas roscadas hembra de 1 1/4" a 4".
Tornillos (Series 17): Acero niquelado.
Tuercas: Acero inoxidable.

Válvulas

Cuerpo: Polipropileno, block copolímero de alta calidad.
Junta tórica: Ver catálogo.
Resorte: (03067, 03039), Acero inoxidable.

Collarines

Cuerpo: Polipropileno, block copolímero de alta calidad.
Tornillos y tuercas: Acero niquelado.
 (También se dispone de tornillos y tuercas de acero inoxidable)
Anillo de refuerzo: Acero inoxidable.
Juntas: NBR.

Tapper y Collarin de compresión

Cuerpo: Polipropileno, block copolímero de alta calidad.
Casquillo de apriete: Acetal (POM).
disponibles también en PVC -C
Racor: Polipropileno, block copolímero de alta calidad.
Tornillos y tuercas: Acero inoxidable.
Juntas: EPDM.

Accesorios roscados

Cuerpo: Polipropileno, block copolímero de alta calidad.
Anillo de refuerzo: Acero inoxidable.

Temperaturas de Trabajo

Los accesorios y las válvulas no son recomendados para usar con agua caliente, aunque soportan las mismas temperaturas que las propias tuberías de polietileno.
 Sin embargo pueden resistir temperaturas inferiores a los cero grados centigrados.

Resistencia a las Sustancias Químicas

Los accesorios **Plasson** están provistos, como estándar, con Casquillos de Apriete de resina acética y Juntas tóricas de NBR, recomendados para usar con agua potable. Para las aplicaciones de productos químicos agresivos se ofrecen Casquillos de Apriete de CPVC y Juntas tóricas de EPDM o FPM, que resisten mejor a las sustancias químicas.

Presiones de Funcionamiento y Certificados de Calidad

Todos los accesorios de **Plasson** se someten a pruebas de aprobación, de conformidad con las normativas ISO14236 y AS/NZ 4129. Para ver una clasificación detallada de las presiones, consulte la página 73.

Roscas

Todas las roscas responden a las normas ISO-7/1, BS 21, DIN 2999, NEN 3258, AS 1722 Part 1 - 1975.

Solo las roscas hembra menores a 3" no son cónicas.
 Todas las otras roscas macho y hembra son cónicas.

Bridas

Las dimensiones de las bridas responden a las normas ISO 7005-1 (TABLE 11), BS 4504:1989 (TABLE 11), DIN 2501 (PN 16 TABLE), AS/NZS 4331.
 Con todas las bridas debe ser utilizado como refuerzo una brida de metal.

Legend

UB	Unidades por bolsa
UC	Unidades por carton
W	Peso en gramos

Nota

Antes de la instalación asegure que:
 El extremo del tubo introducido no tenga imperfecciones o rayaduras Tanto el tubo como el accesorio no tenga sobre los mismos arena, barro o piedras, etc. No cierre el racor con extremada fuerza, nunca use llaves con manijas mas largas de 46 cm. Un excesivo momento de torsion durante el cierre puede dañar el cono del racor y como resultado del mismo no permitir su propio funcionamiento Si los accesorios son usados nuevamente despues de su desarmado, constate que los dientes del casquillo de apriete permanecen afilados y se hincan en el tubo impidiendo el escape del tubo. Si no es asi, cambie el casquillo de apriete.

Nota: Recomendamos utilizar cinta de PTFE para sellar todas las conecciones roscadas

Pressure Rating of Plasson Mechanical Fittings and Valves

Product Code	Body Type	Pressure Rating	Stainless Steel Reinforcement Ring	From Pipe Diameter	To Pipe Diameter	From Thread	To Thread	From Outlet Size	To Outlet Size
Starts with 07 and 87	All Fitting Types	16.0							
Exceptions:									
Starts with 07	All 160 mm Fittings	10.0							
Starts with 07 and 87	All Fittings with 3 inch Female Thread	10.0							
Starts with 07 and 87	All Fittings with 4 inch Female Thread	6.0							
0701070/ 0705070	Class 4 (Universal)	10.0		50	50			35	50
0704P	90° Slip Tee	12.5		40	63				
07120	Plug Adaptor	12.5		20	63				
07220	Compression Flange Adaptor	12.5		125	125				
07250	Threaded Adaptor	12.5		75	75	1.1/2	3		
07640/ 87640	45° Tee	8.0		63	110				
03046/03047/03048/03049	Angle Seat Valve	8.0							
03405	Threaded Stoptap	10.0				3/4	1		
03407	Compression Stoptap	16.0		20	32				
Starts with 05	Female Thread	10.0	NO			1/2	1		
Starts with 05	Female Thread	6.0	NO			1.1/4	2		
Starts with 05	Female Thread	10.0	YES			1.1/4	2		
050207/ 050707	Threaded Reducing Bushing/Threaded Cap	6.0				1.1/4	4		
050207/ 050707	Threaded Reducing Bushing/Threaded Cap	10.0				1/2	1		
050605/ 050607	Threaded Reducing Nipple/Threaded Nipple	10.0				1/2	2		
051607	Threaded Riser	10.0				1/2	1.1/2		
051707	Threaded Plug	10.0				1/2	2		
160760	Saddle Single Outlet	12.5	YES	20	63	1/2	1.1/2		
160760	Saddle Single Outlet	12.5	YES	75	180	1/2	3/4		
160760	Saddle Single Outlet	10.0	YES	75	180	1	2		
160761	Saddle Single Outlet	16.0	YES	40	180	1	1		
160860	Saddle Single Outlet	6.0	NO	20	180	1.1/4	2		
160860	Saddle Single Outlet	10.0	NO	20	180	1/2	1		
161760	Saddle Double Outlet	12.5	YES	20	63	1/2	1.1/2		
161760	Saddle Double Outlet	12.5	YES	75	180	1/2	3/4		
161760	Saddle Double Outlet	10.0	YES	75	180	1	2		
161860	Saddle Double Outlet	6.0	NO	20	180	1.1/4	2		
161860	Saddle Double Outlet	10.0	NO	20	180	1/2	1		
16279	Saddle Single Outlet	16.0	YES	63	180	1.1/2	1.1/2		
16540	All Tappers - for PVC & PE Pipes	16.0							
16810/16820/16830/16860	All Compression Saddles	16.0							

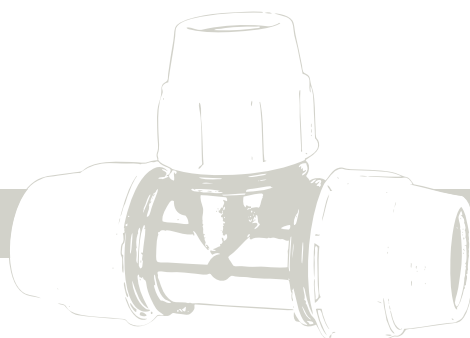

Pression Nominale des Raccords Mecaniques et Vannes

Numero de Catalogue	Type de Corps	Taux de Pression	Anneau de Renforcement en Acier Inoxydable	De Diamètre de Tube	A Diamètre de Tube	De Tailles Filetées	A Tailles Filetées	De Taille de Sortie	A Taille de Sortie
Commence par 07 et 87	Tous Types de Raccords	16.0							
Exceptions:									
Commence par 07	Tous Raccords de 160 mm	10.0							
Commence par 07 et 87	Tous Raccords Femelles Filetés de 3"	10.0							
Commence par 07 et 87	Tous Raccords Femelles Filetés de 4"	6.0							
0701070/ 0705070	Plass4 - (manchon universel)	10.0		50	50			35	50
0704P	Té à 90° de Réparatiön	12.5		40	63				
07120	Bouchon Universel	12.5		20	63				
07220	Raccord à Bride (avec bride de métal)	12.5		125	125				
07250	Adaptateur Fileté	12.5		75	75	1.1/2	3		
07640/ 87640	Té à 45°	8.0		63	110				
03046/03047/03048/03049	Robinet à Soupape Oblique	8.0							
03405	Robinet à Soupape Droite	10.0				3/4	1		
03407	Robinet à Soupape Droite, Embouts Compression	16.0		20	32				
Commence par 05	Raccords Taraudés	10.0	NON			1/2	1		
Commence par 05	Raccords Taraudés	6.0	NON			1.1/4	2		
Commence par 05	Raccords Taraudés	10.0	OUI			1.1/4	2		
050207/ 050707	Manchon de Réduction Fileté/Bouchon Fileté	6.0				1.1/4	4		
050207/ 050707	Manchon de Réduction Fileté/Bouchon Fileté	10.0				1/2	1		
050605/ 050607	Manchon de Réduction Fileté/Mamelon Double Fileté	10.0				1/2	2		
051607	Rallonge filetée	10.0				1/2	1.1/2		
051707	Bouchon filetée	10.0				1/2	2		
160760	Collier de Prise Simple	12.5	OUI	20	63	1/2	1.1/2		
160760	Collier de Prise Simple	12.5	OUI	75	180	1/2	3/4		
160760	Collier de Prise Simple	10.0	OUI	75	180	1	2		
160761	Collier de Prise Simple	16.0	OUI	40	180	1	1		
160860	Collier de Prise Simple	6.0	NON	20	180	1.1/4	2		
160860	Collier de Prise Simple	10.0	NON	20	180	1/2	1		
161760	Collier de Prise Double	12.5	OUI	20	63	1/2	1.1/2		
161760	Collier de Prise Double	12.5	OUI	75	180	1/2	3/4		
161760	Collier de Prise Double	10.0	OUI	75	180	1	2		
161860	Collier de Prise Double	6.0	NON	20	180	1.1/4	2		
161860	Collier de Prise Double	10.0	NON	20	180	1/2	1		
16279	Collier de Prise Double	16.0	OUI	63	180	1.1/2	1.1/2		
16540	Toutes Prises de Branchement Tapper Pour Tube PVC et PE	16.0							
16810/16820/16830/16860	Tous colliers de compression	16.0							

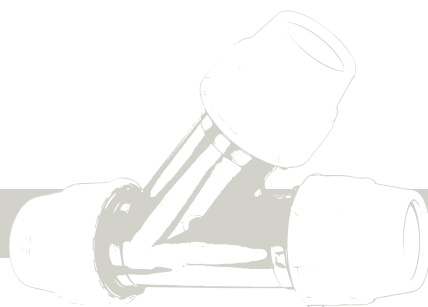

Presiones Nominales (PN) de Los Accesorios y Válvulas Mecánicas/de Compresión de Plasson

Product Code	Tipo	Presión Nominal	Anillo de Refuerzo de Acero Inoxidable	Desde Diámetro	Hasta Diámetro	Desde Diámetro Rosca	Hasta Rosca	Desde Diámetro de Salida	Hasta Diámetro de Salida
Comienza con 07 y 87	Todos Los Accesorios	16.0							
Exepciones:									
Comienza con 07	Accesorios de 160 mm	10.0							
Comienza con 07 y 87	Accesorios con rosca Hembra de 3"	10.0							
Comienza con 07 y 87	Accesorios con rosca Hembra de 4"	6.0							
0701070/ 0705070	Plass 4 (Universal)	10.0		50	50			35	50
0704P	Te de 90° de Reparación	12.5		40	63				
07120	Tapón Final	12.5		20	63				
07220	Adaptador Compresión-Brida	12.5		125	125				
07250	Adaptador Compresión Rosca Macho	12.5		75	75	1.1/2	3		
07640/ 87640	Te de 45°	8.0		63	110				
03046/03047/03048/03049	Válvula de Asiento Angular	8.0							
03405	Válvula de Línea Rosca Hembra	10.0				3/4	1		
03407	Válvula de Línea Compresión	16.0		20	32				
Comienza con 05	Rosca Hembra	10.0	NO			1/2	1		
Comienza con 05	Rosca Hembra	6.0	NO			1.1/4	2		
Comienza con 05	Rosca Hembra	10.0	SI			1.1/4	2		
050207/ 050707	Manguito Roscado/Tapón Rosca Hembra	6.0				1.1/4	4		
050207/ 050707	Manguito Roscado/Tapón Rosca Hembra	10.0				1/2	1		
050605/ 050607	Machón Doble Reductor/Machón Doble	10.0				1/2	2		
051607	Espiga Roscada	10.0				1/2	1.1/2		
051707	Tapón Rosca Macho	10.0				1/2	2		
160760	Collarín Simple	12.5	SI	20	63	1/2	1.1/2		
160760	Collarín Simple	12.5	SI	75	180	1/2	3/4		
160760	Collarín Simple	10.0	SI	75	180	1	2		
160761	Collarín Simple	16.0	SI	40	180	1	1		
160860	Collarín Simple	6.0	NO	20	180	1.1/4	2		
160860	Collarín Simple	10.0	NO	20	180	1/2	1		
161760	Collarín Doble	12.5	SI	20	63	1/2	1.1/2		
161760	Collarín Doble	12.5	SI	75	180	1/2	3/4		
161760	Collarín Doble	10.0	SI	75	180	1	2		
161860	Collarín Doble	6.0	NO	20	180	1.1/4	2		
161860	Collarín Doble	10.0	NO	20	180	1/2	1		
16279	Collarín Doble	16.0	SI	63	180	1.1/2	1.1/2		
16540	Todos los Collarines con Tapper para Tubos PVC y PE	16.0							
16810/16820/16830/16860	Todos los collarines de compresión	16.0							



ASSEMBLY AS SIMPLE AS ABC...

For Fittings **16mm - 63mm** / Pour raccords **16mm à 63mm** / Para accesorios de **16mm - 63mm**

- A** Cut the pipe square, remove burrs • Undo the nut to the last thread. Leave the nut on the fitting while inserting the pipe.
 Couper le tube à l'équerre, ébavurer si nécessaire • Dévisser l'écrou jusqu'au dernier filet. Laisser l'écrou sur le raccord et insérer le tube.
 Corte el tubo al tamaño requerido y realice el biselado al final del tubo • Retire el racor hasta su última rosca dejándolo en el accesorio durante el próximo paso.

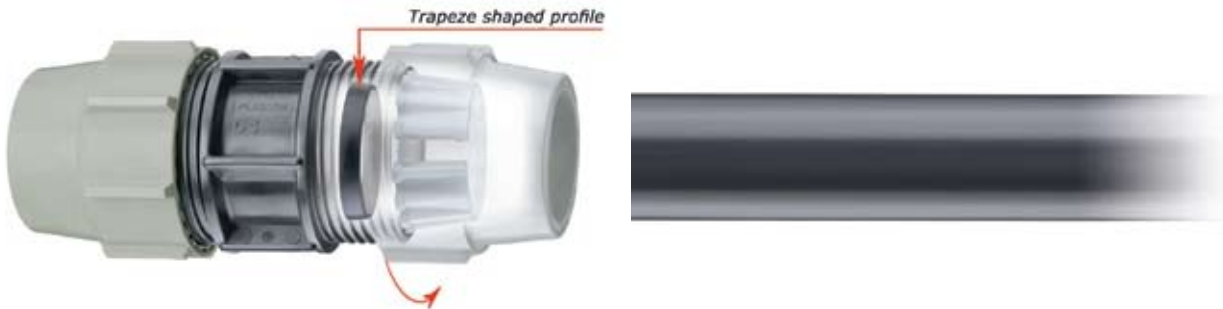

- B** Twist the pipe into the fitting* through the split ring and rubber seal to the pipe stop • Tighten the nut firmly. Use a Plasson wrench (or similar tool) for final tightening of sizes 40 and above.
 Enfoncer le tube en tournant dans le raccord*, Traverser la bague de crampage et le joint caoutchouc pour venir en butée contre l'épaulement intérieur • Visser et serrer l'écrou fermement. Utiliser une clé Plasson (ou équivalent) pour serrer l'écrou des raccords de diamètres supérieurs ou égaux à 40 mm.
 Introduzca el tubo con un movimiento circular dentro del accesorio pasando el casquillo de apriete y el sello hasta llegar al tope interno del accesorio • Gire firmamente el racor en dirección del cuerpo del accesorio, utilizando la llave Plasson (o similar) en los tamaños 40mm y mayores.



- C** The nut should be closed tightly, however there is no need for the nut to actually meet the body shoulder.
 L'écrou doit être bien serré mais ne doit pas nécessairement toucher la butée centrale du corps du raccord.
 Cierre el racor firmemente, aunque no es necesario cerrarlo hasta el tope.



* Lubrication and chamfering of the pipe end will ease insertion of the pipe (use silicone lubricant).

* Lubrifier et chanfreiner l'extrémité du tube rendra l'insertion plus facile (utiliser un lubrifiant au silicone).

* A fin de facilitar la introducción es conveniente lubricar y biselar el tubo (con un lubricante que conforma las normas de aprobación de calidad del agua).

ASSEMBLY AS SIMPLE AS ABC...

For Fittings **75mm - 110mm** / Pour raccords **75mm - 110mm** / Para accesorios de **75mm - 110mm**
 Cut the pipe square, remove burrs / Couper le tube à l'équerre et évaburer

- A** Undo the nut until 3-4 threads are visible.
 Dévisser l'écrou de 3 ou 4 tours.
 Abra el racor hasta que se vean 3-4 roscas.
 Corte el tubo en escuadra y quite las virutas del corte



- B** Insert the pipe into the fitting until the stop.
 Enfoncer le tube jusqu'à la butée intérieure du raccord.
 Introduzca el tubo hasta que éste llegue a tocar perpendicularmente el cuerpo del accesorio.



- C** Tighten the nut firmly with a Plasson wrench.
 Visser l'écrou au maximum et serrer fermement à l'aide d'une clé Plasson.
 Cierre firmemente el racor con la llave Plasson.



Universal Pipe Adaptors: Copper, Galvanised and Imperial U-PVC (Without Pullout Resistance)

Adaptateurs pour tubes en cuivre, galvanisés, UPVC impérial (sans résistance à la traction)

Juegos de conversión de tubería: galvanizada, de cobre o de UPVC medidas imperiales (sin resistencia a la tracción)



Prepare pipe by ensuring that the end is free from grease and roughen the outer surface with wire wool or similar. Cut pipe end square. Remove nut from end of fitting and discard white split ring.



Push adaptor into fitting to the stop. Push and twist the pipe until it meets the internal stop.



Screw nut tightly towards the body of the fitting. Final tightening with a wrench is essential. **The installation should be firmly anchored against end loading.**

Préparer le tube en vous assurant que son extrémité est propre (pas de trace de graisse...). Gratter la surface avec du papier de verre. Couper l'extrémité du tube à l'équerre. Dévisser l'écrou du raccord et enlever la bague de crampage blanche.

Intégrer l'adaptateur dans le raccord jusqu'à la butée. Pousser ensuite le tube dans le raccord (à travers l'adaptateur) jusqu'à la butée intérieure.

Revisser l'écrou fermement en terminant l'opération avec une clé. Il est important de visser l'ensemble très fermement pour éviter tout déboîtement.

Se prepara el tubo asegurándose que el final del tubo no tenga grasa, y se lija el exterior con lana de alambre. Se hace un corte perpendicular al final del tubo. Se lleva el racor al final del accesorio y se quita el casquillo de apriete blanco.

Se empuja el adaptador en el tubo hasta el tope se empuja y se enrosca el tubo hasta que llegue al tope interior del accesorio.

Se aprieta firmemente el racor hacia el interior del accesorio. Es imprescindible que se apriete con una llave. **Después, anclar firmemente la instalación.**

Adaptor Set for Copper (With Pullout Resistance)

Set d'adaptation pour tubes en cuivre (avec résistance à la traction)

Juego de adaptadores para cobre (con resistencia a traccion)



Cut pipe square. Remove burrs. Ensure pipe is free of scratches, dents and other imperfections. Remove nut from fitting and discard white split ring. Make a mark on the pipe to the depth of the rubber insert. Assemble nut, brown ring and stainless steel ring onto pipe in that order. Ensure the brown ring tapers towards the nut and the stainless steel ring towards the fitting body.



Push insert into fitting body fully up to the flange.



Push pipe end into body of fitting. Ensure to insert at least to the mark you have made. Push both the rings up to the insert flange and engage nut. Use a Plasson wrench for final tightening.

Couper le tube à l'équerre et évaburer. Vérifier qu'il n'y a aucune imperfection sur le tube. Dévisser le tube et enlever la bague de crampage blanche. Reporter la longueur de l'adaptateur sur l'extrémité du tube et faire une marque visible. Assembler dans l'ordre l'écrou, l'insert marron et la bague inox sur le tube. Assurez vous après montage que l'insert marron bute contre l'écrou, et la bague inox contre le corps du raccord.

Insérer l'adaptateur dans le raccord jusqu'à la rondelle.

Insérer l'extrémité du tube dans le raccord. S'assurer qu'il est enfoncé jusqu'à la marque que vous avez faite. Pousser les deux inserts vers le raccord jusqu'à la rondelle de l'adaptateur. Visser l'écrou en terminant l'opération avec le clé Plasson.

Corte el tubo a escuadra, limpie los restos del corte. Asegure que el tubo no este rayado, dentado, con virutas o con otras imperfecciones. Se lleva el racor hasta el final del accesorio y se quita el casquillo de apriete blanco. Se hace una marca en la superficie del tubo que es la profundidad del adaptador de goma. Se colocan el racor, el anillo marrón y el anillo de acero en el tubo, en este orden. Se comprueba que el anillo marrón se remata hacia la tuerca y el anillo de acero hacia el interior del accesorio.

Introducir el adaptador en el interior del accesorio hasta el final.

Introducir el tubo en el interior del accesorio. Comprobar que se introduce por lo menos hasta la marca hecha previamente. Se empujan ambos anillos hasta el adaptador de goma y se cierra firmemente el racor. Para apretar firmemente se debe utilizar la llave Plasson.

Lead Pipe Adaptor

Adaptateur pour tubes en plomb
Adaptadores para tuberías de plomo



Remove nut from fitting and discard white split ring. Mount nut on pipe followed by brown split ring and seal ring.



Push both components onto the pipe until the seal ring is 20mm from the end of pipe and touching the split ring.



Enter pipe into fitting body and tighten firmly with a wrench. (It is important that the pipe is not pushed fully to the stop in the fitting).

Note for lead pipe adaptors: This product seals on the outside diameter of the pipe and it is therefore important that the lead pipe is in good condition on the external part of the pipe where the seal is made. Variation in the lead piping sometimes results in oversized pipes. In these circumstances it may be preferable to use the white split ring provided with the fitting.

Dévisser l'écrou et enlever la bague de crantage blanche. Assembler dans l'ordre l'écrou, la bague de crantage marron et le joint sur le tube.

Placer le joint à 20mm de l'extrémité du tube. Rapprocher la bague de crantage marron afin qu'elle soit en contact avec le joint.

Insérer le tube dans le raccord. **ATTENTION:** le tube ne doit pas être inséré exactement jusqu'à la butée. Laisser un peu de jeu. Visser fermement l'écrou en terminant l'opération avec une clé.

NB: L'adaptateur pour tubes en plomb fait étanchéité sur le diamètre extérieur du tube. Il est donc important que la partie du tube en contact avec le joint soit conforme (diamètre, état de surface...). Si les conditions ne sont pas favorables, il est préférable d'utiliser la bague de crantage blanche délivrée avec le raccord à compression.

Se lleva el racor al final del accesorio y se quita el casquillo de apriete blanco. Se monta el racor al tubo seguido por el casquillo marrón y el anillo de goma.

Se empujan los dos componentes hasta que el anillo de goma esté a 20mm del final del tubo, y tocando el casquillo de apriete marrón.

Se introduce el tubo en el interior del accesorio y se aprieta firmemente con una llave (es importante que no se empuje el racor completamente hasta el final del accesorio).

Nota: El sellado con este producto se realiza con el diámetro exterior del tubo, y por lo tanto es importante que el exterior de la tubería de plomo esté en buen estado. Los variaciones en la tubería de plomo resultan a veces demasiado grandes. En estas circunstancias es preferible usar el casquillo de apriete que está previsto con el accesorio.

Installation Instructions for PLASS4 (Universal) Fittings

Instructions de montage des raccords PLASS4 (universels) Instrucciones para la instalacion de accesorios plass4



Cut the pipe square and remove all burrs and sharp edges.

- Select correct fitting according to the external diameter of the pipe.
- Slide the PLASS4 fitting (universal side) onto the pipe, until it reaches the internal fins and a slight resistance is felt. Do not force the pipe end past the fins.
- Holding the PLASS4 body with a wrench, tighten the PLASS4 universal nut firmly with a wrench (size 35-50 tighten nut very firmly to approx. 90 NM)
- Assemble the metric PE joint as per the standard fitting instructions.

Note: If reusing the fitting, ensure the metal teeth are located in the grip ring and pipe end does not pass the location fins in the body.

Côté universel: Eliminer tout dommage ou impureté apparaissant sur le tube PE. Couper à l'équerre et ébavurer l'extrémité du tube à raccorder.

- Choisir le raccord de diamètre approprié en fonction du diamètre externe du tube.
- Insérer le tube dans le PLASS4 jusqu'à atteindre les ailettes intérieures et jusqu'à ce qu'une légère résistance soit rencontrée. Ne pas insérer le PLASS4 au delà de ce point.
- Tout en maintenant le raccord PLASS4 avec une clé, serrer l'écrou universel PLASS4 fermement avec une clé supplémentaire (la clé de taille 35-50 resserre l'écrou jusqu'à environ 90 NM).
- Assembler le côté métrique du tube PE selon les instructions de montage Plasson standard.

REMARQUE: en cas de réutilisation du PLASS4, s'assurer que les dents de la bague de crampage métallique sont toutes présentes et que le bout du tuyau de dépasse pas les ailettes intérieures.

Corte el tubo a escuadra y elimine todas las virutas y cantos vivos.

Elija el accesorio apropiado de acuerdo con el diámetro del tubo. Introduzca el accesorio PLASS4 (del lado Universal) en el tubo hasta que llegue al tope s sienta una ligera resistencia. No fuerce el tubo y no pase las aletas. Agarrando el cuerpo del PLASS4 con una llave apropiada, cierre firmamente el raccor con una llave (en las medidas 35-50 su raccor puede ser cerrado con un momento de 90 Nm). Arme la union de PE como en las instrucciones de los accesorios normales.

IMPORTANTE: no fuerce el tubo y pase el punto de resistencia. Puede danar el el accesorio. Comience apretar la tuerca al cuerpo. el cierre final hagalo con una llave plasson o similar. Ensamble la junta metrica como las instrucciones de un accesorio estandard.

Installation Instructions for Copper Pipe Adaptor

Instructions de montage pour adaptateur pour tube en cuivre Instrucciones para la instalacion de adaptor tubo de cobre



Cut the copper pipe square and remove all burrs and sharp edges.

Twist the copper pipe into the fitting* through the rubber o-ring to the pipe stop.

Tighten the nut firmly. Use a wrench for final tightening. The nut should be closed tightly, however there is no need for the nut to actually meet the body shoulder.

Assemble the metric PE joint as per the standard fitting instructions.

* Lubrication of the pipe end will ease the insertion (use silicone lubricant).
Note: If reused, the metal grip ring must be replaced with a new one.

Couper le tube de cuivre à l'équerre. Ebavurer l'extrémité du tube à raccorder.

Introduire le tube de cuivre dans le raccord* en le tournant, passer le joint torique et insérer le tube jusqu'à la butée.

Visser l'écrou. Pour le serrage final, utiliser une clé. L'écrou doit être vissé fermement mais il n'est pas nécessaire qu'il atteigne la butée centrale du corps du raccord.

Raccorder le tube PE selon les instructions de montage Plasson standard.

*La lubrification de l'extrémité du tube cuivre facilite son insertion dans le raccord (utiliser un lubrifiant silicone).

En cas de ré-utilisation, remplacer l'ancienne bague de crampage métallique par une neuve.

Corte el tubo a escuadra y elimine todas las virutas y cantos vivos.

Introduzca girando* el tubo de cobre junto con el o-ring hasta el tope. Apriete la tuerca firmemente. use una llave para el apriete final. La tuerca debe estar apretada hermeticamente. Sin embargo no es necesario que llegue hasta el borde del cuerpo.

Ensamble la junta metrica pe como un accesorio estandard.

* Para facilitar la introduccion utilice un lubricante a base de silicona.

NOTA: Si quiere reusar el accesorio debe reemplazar el agarre de metal por uno nuevo.



Global
Presence
Local
Commitment

 **PLASSON**[®]

PLASSON Ltd.

Maagan Michael

D.N. Menashe 37805 Israel

Tel: +972-4-6394711

Fax: +972-4-6390887

E-mail: sales@plasson.com

www.plasson.com

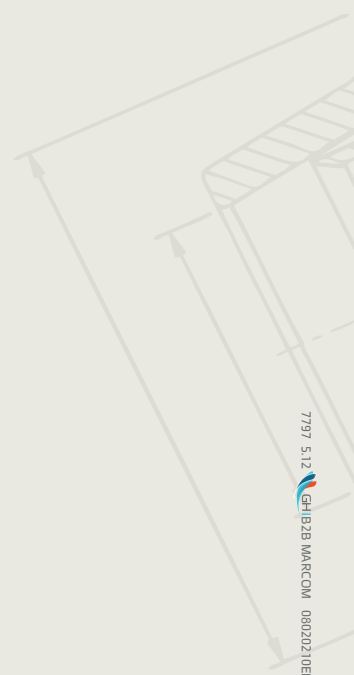

7797 512  GILBEN MARCOM 08020210EFS_12