

ElectroFusion Fittings

ENGLISH
ESPAÑOL

Product List and Technical Catalogue / Lista de productos y catálogo técnico

2013



Introduction

ElectroFusion System	3
Table of Contents	4 - 6
Fittings	7 - 32
Wastewater Line	33 - 37
Technical Specifications	38
Controllers	40 - 45
Installation Tools	52 - 54

PLASSON, a worldwide leader in fittings for polyethylene pipes for over 40 years, now offers a complete line of ElectroFusion products including: Plasson ElectroFusion fittings, tools and control boxes.

Plasson ElectroFusion products combine to offer a reliable smart-system solution featuring fully computerized control and monitoring.

PLASSON's customers benefit from the Company's quality products, expertise and worldwide first-rate service in water, gas distribution and industrial applications.

Subsidiary Companies

Australia

Plasson Australia (PTY) Ltd.
E-mail: info@plasson.com.au
www.plasson.com.au

France

Plasson France S.A.
E-mail: commercial@plassonfrance.fr
www.plasson.fr

Germany

Plasson GmbH
E-mail: info@plasson.de
www.plasson.de

Italy

Plasson Italia
E-mail: info@plasson.it
www.plasson.it

Spain

Plasson Spain S.L.
E-mail: plasson@plasson.es
www.plasson.es

United Kingdom

Plasson UK Ltd.
E-mail: miron@plasson.co.uk
www.plasson.co.uk

Poland

Plasson Polska Sp.z o.o.
E-mail: bs@plasson.pl
www.plasson.pl

USA

IPF Industrial Pipe Fittings, LLC
E-mail: sales@hdpefittings.com
www.hdpefittings.com

Introducción

Sistema ElectroFusión	3
Indice	4 - 6
Accesorios	7 - 32
Aguas residuales	33 - 37
Especificaciones técnicas	39
Soldadoras automáticas	46 - 51
Herramientas de instalación	52 - 54

PLASSON, líder mundial en accesorios para tuberías de polietileno desde hace más de 40 años, presenta ahora una línea completa de productos de electrofusión, entre ellos: conectores, herramientas y soldadoras automáticas de ElectroFusión. La combinación de productos ElectroFusion de Plasson ofrece una solución inteligente y confiable que integra el control y la monitorización completamente computarizados.

Los clientes de **PLASSON** se benefician de los productos de calidad, la pericia y el excelente servicio mundial de la compañía en instalaciones de distribución de agua y gas, y aplicaciones industriales.

Subsidiarias

Australia

Plasson Australia (PTY) Ltd.
E-mail: info@plasson.com.au
www.plasson.com.au

Francia

Plasson France S.A.
E-mail: commercial@plassonfrance.fr
www.plasson.fr

Alemania

Plasson GmbH
E-mail: info@plasson.de
www.plasson.de

Italia

Plasson Italia
E-mail: info@fiver.it
www.fiver.it

España

Plasson Spain S.L.
E-mail: plasson@plasson.es
www.plasson.es

Reino Unido

Plasson UK Ltd.
E-mail: miron@plasson.co.uk
www.plasson.co.uk

Polonia

Plasson Polska Sp.z o.o.
E-mail: bs@plasson.pl
www.plasson.pl

USA

IPF Industrial Pipe Fittings, LLC
E-mail: sales@hdpefittings.com
www.hdpefittings.com

Plasson ElectroFusion System

The Smart-System Solution You Can Depend On

Plasson ElectroFusion Fittings

Plasson fittings are specifically designed for reliable, high performance pipe joining and long system life. This automated system has been proven to be most economical due to the low potential for operator error.

Tools and Control Box

Plasson offers quality tools and control boxes allowing for easy installation. Plasson control boxes provide computerized ElectroFusion with minimal potential for operator error. The Plasson control boxes are the economical solution for reliable ElectroFusion.

The Smart System-Plasson ElectroFusion

All Plasson products combine to form the latest state-of-the-art high performance pipe joining solution. Plasson ElectroFusion fittings are part of a complete ElectroFusion smart system. The entire ElectroFusion process is executed and fully monitored by the computerized control box. Everything is computer-controlled ensuring safe, dependable connections.

Plasson ElectroFusion fittings can be used with Plasson's computerized smart system control box or with standard barcode systems. Each Plasson ElectroFusion fitting comes complete with a barcode.

Plasson ElectroFusion Smart System Features

- ◆ **Superior Fitting Design**
increases joint integrity
- ◆ **Automatic Controller**
decreases potential operator error
- ◆ **Computerized Data Retrieval**
ensures quality control by Joint Data retrieval of measurements and records
- ◆ **Compatibility**
between Plasson ElectroFusion and other ElectroFusion systems through the computerized barcode system
- ◆ **Easy Installation**
using PLASSON's simple, practical tools
- ◆ **High Standards**
are ensured by the latest product testing methods

Advantages

Stronger pipe joining - Plasson ElectroFusion quality fittings have long penetration depths and fusion zones which ensure high quality joints. **Most Economical** - Economic benefits are a result of overall integrated system quality and innovation including the computerized smart system which reduces the potential for operator error. **High Performance** - Proven high performance in gas and water distribution and industrial applications. **Superior Service** - Plasson provides unmatched service based on over 40 years in the field.

Sistema ElectroFusion de Plasson

La solución inteligente de confianza

Accesorios ElectroFusion de Plasson

Los accesorios ("fittings") de Plasson para tuberías han sido especialmente diseñados para asegurar conexiones fiables, de alto rendimiento y prolongada vida útil. Se ha comprobado que este sistema automatizado es el más económico, gracias a la escasa probabilidad de errores por parte del operador.

Herramientas y soldadora automática de ElectroFusión

Plasson ofrece herramientas de alta calidad y soldadoras automáticas que se instalan fácilmente. Las soldadoras, que proporcionan un proceso computarizado con mínima probabilidad de error humano, son la solución más económica para una electrofusión de máxima confianza.

ElectroFusion de Plasson - El sistema inteligente

Los productos de Plasson se combinan para ofrecer la solución más avanzada y rendidora en la conexión de tuberías. Los accesorios ElectroFusion de Plasson forman parte de un sistema completo e inteligente. La soldadora automática de ElectroFusión está a cargo de la ejecución y la monitorización del proceso. El sistema controlado por computadora asegura conexiones seguras y confiables.

Características del sistema inteligente ElectroFusion de Plasson

- ◆ **Excelente diseño**
asegura la integridad de la conexión
- ◆ **Control automático**
reduce la probabilidad de error humano
- ◆ **Recuperación de datos**
calidad asegurada mediante la recuperación de datos de mediciones y registros
- ◆ **Compatibilidad**
con el sistema ElectroFusion de Plasson y otros sistemas de códigos de barras
- ◆ **Instalación sencilla**
mediante las herramientas prácticas y simples de PLASSON
- ◆ **Estándar elevado**
asegurado por los métodos de prueba de productos de última generación

Ventajas

Uniones más resistentes - Los accesorios de alta calidad ElectroFusion de Plasson tienen grandes profundidades de penetración y zonas de fusión que aseguran juntas muy resistentes. **La solución más económica** - El beneficio económico es el resultado de la calidad y la innovación del sistema computarizado totalmente integrado, que reduce la probabilidad de error humano. **Alta performance** - Elevado rendimiento comprobado en instalaciones de distribución de gas y agua, y aplicaciones industriales. **Excelente servicio** - Plasson le brinda un servicio inigualado, con su pericia y experiencia de más de 40 años en el terreno.

<p>490104/490103 Coupler Enlace Recto</p>		<p>Page 7</p>	<p>499404 Flanged Tee Enlace T Bridado</p>		<p>Page 14</p>
<p>4901L4 Long Coupler Enlace Largo</p>		<p>Page 8</p>	<p>490504 Elbow 90° Codo 90°</p>		<p>Page 14</p>
<p>450104 Coupler (PN 25) Enlace Recto (PN 25)</p>		<p>Page 8</p>	<p>490604 Elbow 45° Codo 45°</p>		<p>Page 14</p>
<p>460104/460103 LightFit Coupler Enlace LightFit</p>		<p>Page 9</p>	<p>490804 Elbow 22.5° Codo 22.5°</p>		<p>Page 15</p>
<p>491104 Reducing Coupler Enlace Reductor</p>		<p>Page 10</p>	<p>46060 LightFit Elbow 45° Codo LightFit 45°</p>		<p>Page 15</p>
<p>491107 Spigot Reducer Reductor Espiga</p>		<p>Page 10</p>	<p>46330 LightFit Elbow 30° Codo LightFit 30°</p>		<p>Page 15</p>
<p>494204 Monolithic End Cap Tapón Monolitico</p>		<p>Page 11</p>	<p>46370 LightFit Elbow 15° Codo LightFit 15°</p>		<p>Page 15</p>
<p>491204 End Cap Tapón</p>		<p>Page 11</p>	<p>490904 Elbow 180° Codo 180°</p>		<p>Page 16</p>
<p>491207 Spigot End Plug Tapón Espiga</p>		<p>Page 12</p>	<p>491904 Y Reducer Y Reductor</p>		<p>Page 16</p>
<p>490404 Tee 90° Enlace T 90°</p>		<p>Page 12</p>	<p>491504 Duckfoot Elbow 90° Codo 90° Empotrable</p>		<p>Page 16</p>
<p>492404 Two Outlets Reducing Tee Enlace te Reductor con Salida Doble</p>		<p>Page 13</p>	<p>4915Q4 Duckfoot Elbow 90° with Outlet Codo 90° Empotrable con Toma de Servicio</p>		<p>Page 17</p>
<p>491404 Reducing Tee Enlace Reductor</p>		<p>Page 13</p>	<p>4947C4 Adjustable Elbow Codo Ajustable</p>		<p>Page 17</p>

4947D4 Adjustable Elbow One Sided Codo Ajustable Enlace/Espiga		Page 17	492104 Male Transition Coupler Enlace de Transición Macho		Page 25
496804 Balloon Saddle Collarín Globo		Page 18	493104 Female Transition Coupler Enlace de Transición Hembra		Page 25
4958T Saddle BSPP Female Outlet Collarín BSPP Rosca Hembra		Page 18	492504 Male Transition Elbow 90° Codo de Transición de 90° Macho		Page 26
495204 Repair Saddle Toma de Reparación		Page 18	493504 Female Transition Elbow 90° Codo de Transición de 90° Hembra		Page 26
493804 Transition Saddle Collarín de Transición		Page 19	492604 Male Transition Elbow 45° Codo de Transición de 45° Macho		Page 27
498304 Monolithic Weld End Cap for Ballon Saddle Tapón Monolítico Soldable para Collarín Globo		Page 19	493604 Female Transition Elbow 45° Codo de Transición de 45° Hembra		Page 27
495804 Branch Saddle Collarín de Derivación		Page 20	4941M4 Male Free Nut Transition Coupler Enlace de Transición, Tuerca Libre Macho		Page 27
496304 Tapping Saddle Toma de Servicio		Page 21	494104 Female Free Nut Transition Coupler Enlace de Transición Tuerca Libre Hembra		Page 28
4963P4 Tapping Saddle Parallel Outlet Toma de Servicio Salida Paralela		Page 22	4945M4 Male Free Nut Transition Elbow 90° Codo de Transición de 90° Tuerca Libre Macho		Page 28
498304 Welding Cap for Tapping Saddle Tapón Soldable para toma de Servicio		Page 23	494504 Female Transition Elbow 90° Codo de Transición de 90° Tuerca Libre, Hembra		Page 28
436207 PE Ball Valve Válvula de Bola PE		Page 23	4946M4 Male Free Nut Transition Elbow 45° Codo de Transición de 45° Tuerca Libre, Macho		Page 29
495404/4954S4 Tapping Valve Toma de Servicio con Válvula		Page 24	494604 Female Free Nut Transition Elbow 45° Codo de Transición de 45° Tuerca Libre Hembra		Page 29

<p>494404 Female Union Free Nut Transition Tee Enlace T PE/Latón Tuerca Libre Hembra</p>		<p>Page 29</p>	<p>4758S4 Wastewater Saddle Spigot Inlet Collarín Lightfit para aguas residuales con salida espiga</p>		<p>Page 35</p>
<p>497104 PE Male Transition Coupler Enlace de Transición PE Macho</p>		<p>Page 30</p>	<p>4747D4 Wastewater Adjustable Elbow One Sided Codo Ajustable para Aguas Residuales Enlace/Espiga</p>		<p>Page 35</p>
<p>497504 PE Male Transition Elbow 90° Codo de Transición PE de 90° Macho</p>		<p>Page 30</p>	<p>37020/477207 Wastewater Manhole Adaptor Adaptador para Pozo de Aguas Residuales</p>		<p>Page 35</p>
<p>497604 PE Male Transition Elbow 45° Codo de Transición PE de 45° Macho</p>		<p>Page 30</p>	<p>4701V4 Waste Water PE to PVC Adaptor Adaptador Para PE A PVC</p>		<p>Page 36</p>
<p>497704 PE Cast Iron Flange Transition Coupler Enlace de Transición Bridado - PE/Hierro Fundido</p>		<p>Page 31</p>	<p>4747V4 Wastewater Adjustable Elbow PE to PVC Codo Ajustable de Transición de PE a PVC</p>		<p>Page 36</p>
<p>495704 PE Cast Iron Spigot Transition Coupler Enlace de Transición Espiga - PE/Hierro Fundido</p>		<p>Page 31</p>	<p>37980 Wastewater Adaptor for Clay Pipe Adaptador para Tubería Cerámica</p>		<p>Page 36</p>
<p>490209 Full Face Flange Brida de Cara Plana</p>		<p>Page 31</p>	<p>37117 Wastewater Spigot Adaptor for Clay Pipe Adaptador Espiga para Tubería Cerámica</p>		<p>Page 37</p>
<p>490207 Flange Adaptor Adaptador de Brida</p>		<p>Page 32</p>	<p>470604 Wastewater Elbow 45° Codo 45° Para Aguas Residuales</p>		<p>Page 37</p>
<p>09903 Flange Backing Ring Brida Revestida</p>		<p>Page 32</p>	<p>473304 Wastewater Elbow 30° Codo 30° Para Aguas Residuales</p>		<p>Page 37</p>
<p>475804 Wastewater Adjustable Saddle Ramal para Aguas Residuales</p>		<p>Page 34</p>	<p>473704 Wastewater Elbow 15° Codo 15° Para Aguas Residuales</p>		<p>Page 37</p>
<p>4758A4 Wastewater Saddle 45° Inlet 110 Ramal 45° de Salida para Aguas Residuales</p>		<p>Page 34</p>	<p>Page 40-51</p> <p>PLASSON Control Boxes Soldadora Automática de ElectroFusión de Plasson</p> 		
<p>4758V4 Wastewater Saddle PVC/PP Adaptor Inlet Collarín Lightfit de transición para Aguas Residuales de PE A PP/PVC</p>		<p>Page 34</p>		<p>Page 52-55</p> <p>Installation Tools Herramientas de Instalación</p> 	

Coupler

Enlace Recto

490104

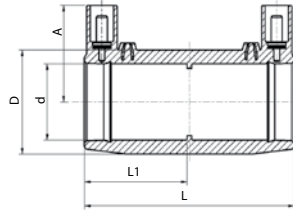

20mm up to 75mm

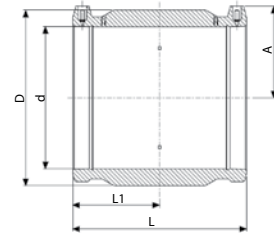

90mm up to 560mm

Size d	L	L1	D	A	W	UC
16	71	34	35	39	57	480
20	76	37	31	34	49	440
25	82	40	36	37	39	360
32	88	42	44	42	63	256
40	97	47	56	46	96	200
50	101	49	67	51	147	132
63	117	57	82	57	230	72
75	126	61	98	64	340	60
90	148	73	117	70	566	38
110	162	78	140	81	859	23
125	173	85	157	87	1075	18
140	183	90	174	97	1295	12
160	195	93	194	105	1550	6
180	212	105	218	116	2112	4
200	223	109	242	126	2785	4
225	240	119	272	138	3900	4
250	251	123	311	156	4461	2
280	275	134	340	170	6440	1
315	282	139	387	184	8845	1
355	277	137	431	203	10200	1
400	293	145	485	231	13800	1

490103

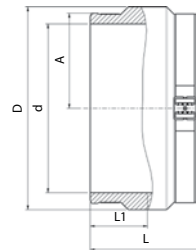

Size d	L	L1	D	A	W	UC*
450	306	153	539	257	15800	5
500	340	170	603	283	20200	5
560	376	188	674	317	28000	5
630	418	209	759	356	41100	4
710	472	236	853	400	62000	4
800*	-	-	-	-	-	-

* Available 2nd Quarter 2013

* A la venta desde mediados de 2013

Optimal order quantity for packing on two stacked pallets

Cantidad óptima para embalaje en dos pallets apilados.

Long Coupler

4901L4

Enlace Largo

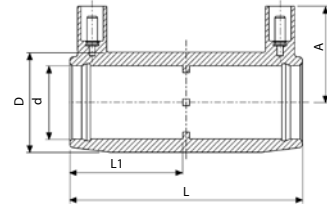

Size d	L	L1	D	A	W	UC
32	104	50	44	43	83	272
40	176	87	56	46	135	128
50	195	96	68	51	215	96
63	213	105	82	57	317	48

Coupler (PN 25)

450104

Enlace Recto (PN 25)

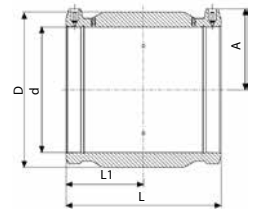
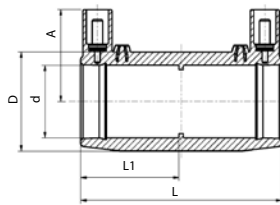

Size d	L	L1	D	A	W	UC
50	100	49	68	52	147	132
63	118	57	82	57	230	72
75	126	62	97	65	339	60
90	148	73	117	69	566	38
110	163	80	140	79	835	23
125	173	85	157	87	1075	18
160	198	97	198	105	1780	6
180	212	104	224	114	2449	4
200	223	110	249	126	3295	4
225	240	118	280	140	4366	4
250	256	126	310	155	5520	2
280	275	134	341	167	6440	1
315	282	139	388	184	8845	1

LightFit Coupler (PN10)

460104

Enlace LightFit (PN10)

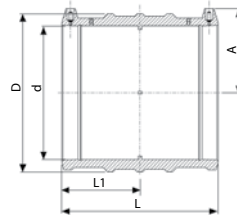

Size d	L	L1	D	A	W	UC
40	90	43	56	47	96	200
50	100	49	68	52	98	132
63	118	57	77	57	98	112
75	126	61	90	63	214	60
90	148	72	108	69	360	44
110	163	80	131	79	540	25
125	173	85	149	87	740	20
140	182	89	167	94	970	12
160	198	97	193	104	1320	6
180	212	104	215	114	1650	5
200	232	114	235	127	2100	4
225	240	118	264	141	2825	4
250	256	126	293	155	3728	2
280	275	135	332	166	4850	1
315	284	140	374	184	6950	1
355	280	138	421	204	7980	1
400	296	146	474	227	11893	1

460103

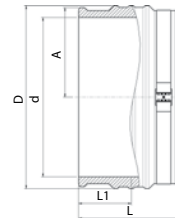

Size d	L	L1	D	A	W	UC*
450	310	155	518	255	11700	5
500	340	170	576	283	16000	5
560	376	188	645	317	21500	5
630	418	209	726	356	30820	4
710	472	236	817	400	43100	4
800	500	250	913	450	57300	4

* Optimal order quantity for packing on two stacked pallets

* Cantidad óptima para embalaje en dos pallets apilados.

Reducing Coupler

491104

Enlace Reductor

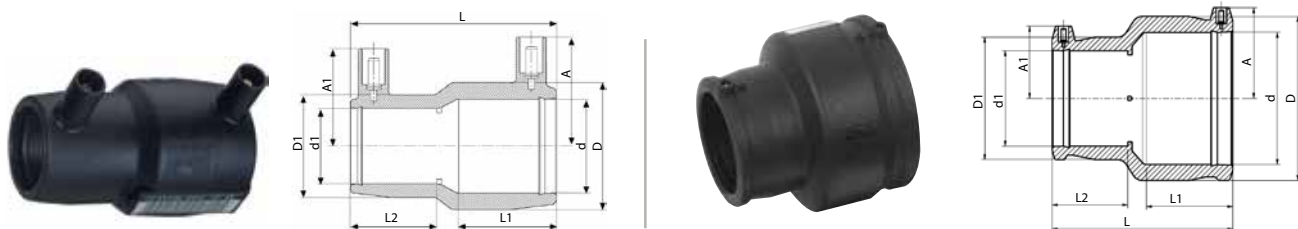

20x16mm up to 110x90mm

125x90mm up to 180x125mm

Size dxd1	L	A	A1	L1	L2	D	D1	W	UC
20 x 16	71	39	39	35	35	36	36	54	480
25 x 20	71	39	39	35	35	36	36	45	480
32 x 20	81	43	37	40	35	45	32	59	360
32 x 25	81	43	39	40	35	45	36	55	360
40 x 25	90	47	38	44	40	56	37	85	200
40 x 32	90	47	43	44	40	56	44	92	160
50 x 25	100	52	41	49	41	68	37	117	-
50 x 32	100	52	45	49	40	68	45	123	128
50 x 40	100	52	48	49	44	68	56	135	128
63 x 32	119	59	45	57	40	82	45	179	96
63 x 40	119	59	49	57	44	82	56	192	96
63 x 50	119	59	54	57	49	82	68	223	80
75 x 63	126	66	59	66	57	98	82	307	65
90 x 50	143	78	53	71	49	116	69	430	54
90 x 63	143	78	61	71	57	116	82	460	44
90 x 75	143	78	67	71	61	116	98	480	41
110 x 63	161	84	61	78	57	139	82	639	32
110 x 90	161	84	74	78	72	139	116	740	23
125 x 90	171	88	70	85	72	158	116	1019	18
125 x 110	171	88	80	85	78	158	141	1025	18
160 x 90	193	105	69	94	72	199	116	1440	12
160 x 110	193	105	80	94	81	199	141	1520	12
160 x 125	195	105	89	94	85	199	158	1570	6
180 x 125	212	116	87	103	85	222	158	2060	6

Spigot Reducer

491107

Reductor Espiga

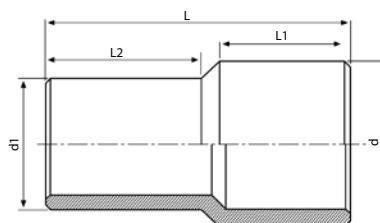

Size dxd1	L	L1	L2	W	UC
32 x 25	104	50	48	30	240
40 x 32	123	59	56	47	240
50 x 32	131	59	60	55	264
50 x 40	129	59	56	80	160
63 x 32	131	59	58	105	144
63 x 40	132	59	58	110	144
63 x 50	132	60	60	125	128
75 x 40	145	71	60	167	96
75 x 50	145	71	59	175	96
75 x 63	151	71	65	195	72
90 x 50	156	81	59	258	56
90 x 63	160	80	65	275	48
90 x 75	166	80	71	320	40
110 x 63	167	83	66	455	36
110 x 75	169	83	72	446	36
110 x 90	178	83	80	505	28
125 x 90	186	90	81	805	24
125 x 110	188	90	84	800	18
140 x 90	208	95	80	815	16
140 x 110	195	95	83	935	16
140 x 125	199	95	89	1000	16
160 x 110	219	101	84	1145	18
160 x 125	206	101	88	1210	16
160 x 140	211	101	94	1240	12
180 x 125	221	107	89	1422	10
180 x 140	224	107	95	1600	10
180 x 160	225	107	100	1756	8
200 x 140	229	114	93	2002	6
200 x 160	233	115	100	2160	6
200 x 180	241	116	106	2330	6

Maximum Pressure: PN 16 (cold water).

Presión Máxima: PN 16 (agua fría).

Sizes and pressure grades not shown in the above table are available upon request.

Los tamaños y presiones no enunciados en la tabla están disponibles a pedido.

Monolithic End Cap

494204

Tapón Monolítico

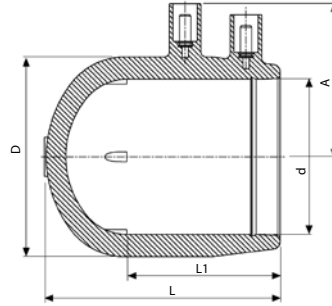

Size d	L	L1	D	A	W	UC
32	63	44	44	46	50	432
40	70	48	55	51	75	256
50	82	55	68	56	122	192
63	95	62	81	62	181	96

End Cap

491204

Tapón

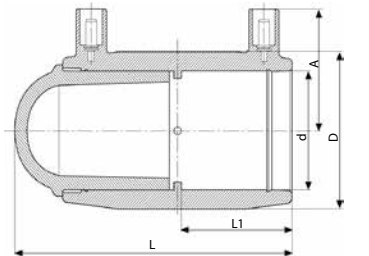

20mm up to 75mm

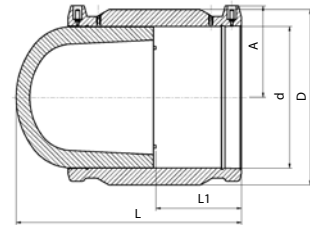

90mm up to 315mm

Size d	L	L1	D	A	W	UC
20	84	37	31	34	55	400
25	92	40	36	37	50	400
32	103	42	44	42	76	300
40	114	47	56	46	130	160
50	121	49	67	51	204	120
63	142	57	82	57	327	72
75	156	61	98	64	499	48
90	183	73	117	70	820	30
110	206	78	140	81	1259	20
125	222	85	157	87	1702	15
140	237	90	174	97	2346	10
160	261	93	194	105	2990	6
180	283	105	218	116	4159	5
200	289	109	242	126	5260	4
225	318	119	272	138	7260	2
250	344	123	311	156	8795	1
280	396	134	340	170	8795	1
315	405	139	387	184	8795	1

Spigot End Plug

491207

Tapón Espiga

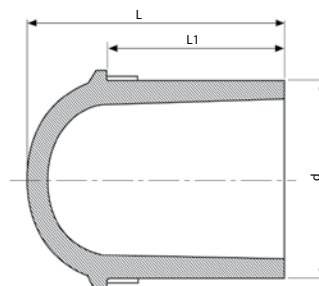

Size d	L	L1	W	UC
20	43	35	8	2000
25	46	36	10	1600
32	52	39	17	960
40	59	43	29	560
50	68	48	52	352
63	81	57	94	160
75	90	60	149	132
90	105	70	250	72
110	121	78	430	57
125	131	82	596	36
140	142	87	797	25
160	157	94	1149	18
180	172	101	1600	14
200	178	112	2089	10
225	196	120	2800	8
250	216	130	3920	4
280	257	162	5300	3
315	262	167	7200	2

Tee 90°

490404

Enlace T 90°

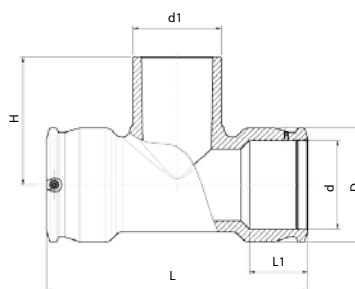
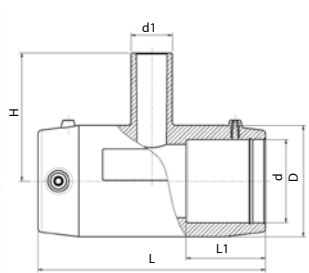

20mm up to 75mm

90mm up to 250mm

Size dx1xd	L	L1	D	H	A	W	UC
20 x 20 x 20	96	37	33	60	28	60	200
25 x 25 x 25	103	39	44	66	30	109	168
32 x 32 x 32	104	39	44	74	27	96	144
40 x 40 x 40	120	43	56	90	26	165	96
50 x 50 x 50	139	48	68	102	26	257	56
63 x 63 x 63	167	58	82	119	27	417	32
75 x 75 x 75	196	63	96	129	23	638	26
90 x 90 x 90	294	71	113	137	25	1090	15
110 x 110 x 110	326	71	143	160	25	1955	8
125 x 125 x 125	382	86	165	177	25	2950	4
160 x 160 x 160	440	86	208	206	24	4700	3
180 x 180 x 180	422	106	245	250	25	7200	2
200 x 200 x 200	451	114	261	265	24	8650	1
225 x 225 x 225	494	122	293	290	26	11860	1
250 x 250 x 250	538	129	326	315	152	16250	1

Two Outlets Reducing Tee

492404

Enlace te Reductor con Salida Doble

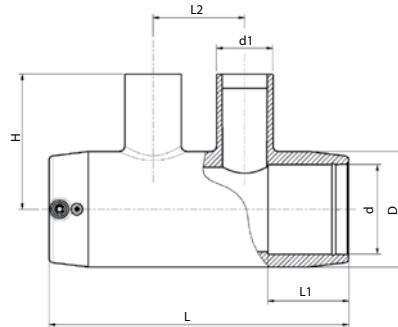

Size dxd1 - d1xd	L	L1	L2	D	H	A	W	UC
40 x 25 - 25 x 40	176	46	57	56	40	46	228	96
40 x 32 - 32 x 40	176	46	57	56	40	46	233	75
50 x 25 - 25 x 50	195	49	65	68	50	51	342	56
50 x 32 - 32 x 50	195	49	65	68	50	51	336	58
50 x 40 - 40 x 50	195	49	65	68	50	51	352	52
63 x 25 - 25 x 63	213	58	65	82	63	57	457	42
63 x 32 - 32 x 63	213	58	65	82	63	57	464	40
63 x 40 - 40 x 63	213	58	65	82	63	57	480	36

Reducing Tee

491404

Enlace T Reductor

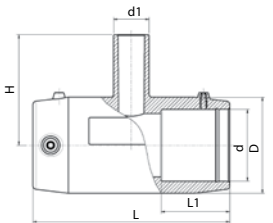

20mm up to 75mm

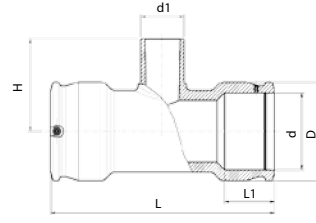

90mm up to 250mm

Size dxd1xd	L	L1	D	H	A	W	UC
25 x 20 x 25	104	39	44	66	43	108	168
25 x 32 x 25*	104	39	44	74	43	116	168
32 x 20 x 32	104	39	44	66	43	89	144
32 x 25 x 32	104	39	44	66	43	91	144
40 x 20 x 40	120	43	56	72	47	151	96
40 x 25 x 40	120	43	56	72	47	150	96
40 x 32 x 40	120	43	56	75	47	152	96
50 x 20 x 50	139	48	68	78	52	224	64
50 x 25 x 50	139	48	68	78	52	225	64
50 x 32 x 50	139	48	68	86	52	228	64
50 x 40 x 50	139	48	68	90	52	237	64
63 x 20 x 63	167	49	82	85	58	348	40
63 x 32 x 63	167	58	82	93	58	353	32
63 x 40 x 63	167	58	82	104	58	365	32
63 x 50 x 63	167	58	82	109	58	381	32
75 x 63 x 75	196	63	96	122	62	607	26
90 x 63 x 90	294	68	113	124	71	1050	15
110 x 63 x 110	326	71	143	134	81	1715	9
110 x 90 x 110	326	71	143	147	81	1815	8
125 x 90 x 125	382	86	165	161	88	2805	5
125 x 110 x 125	382	86	165	173	88	2859	5
160 x 90 x 160	440	86	208	180	106	4450	3
160 x 110 x 160	440	86	208	193	106	4450	3
160 x 125 x 160	440	86	208	198	106	4470	3
180 x 90 x 180	422	106	245	200	116	6090	2
180 x 110 x 180	422	106	245	219	116	6270	2
180 x 125 x 180	422	106	245	225	116	6410	2
180 x 140 x 180	422	106	245	237	116	6610	2
180 x 160 x 180	422	106	245	250	116	6950	1
200 x 90 x 200	451	114	261	205	125	7140	2
200 x 110 x 200	451	114	261	210	125	7235	2
225 x 90 x 225	494	122	293	220	140	9900	1
225 x 110 x 225	494	122	293	225	140	10000	1
250 x 90 x 250	538	129	326	235	152	13350	1
250 x 110 x 250	538	129	326	240	152	13400	1

* This size enlarges

* Esta media agranda

Flanged Tee

Enlace T Bridado

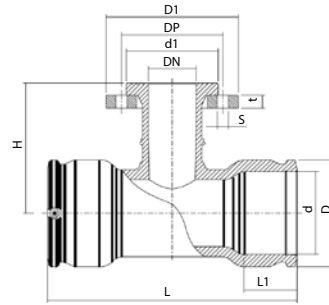

499404

Size d x DN x d	L	L1	D	H	A	D1	t	s	d1	DP	W	UC
90 x 80 x 90	294	71	113	165	71	200	20	8 x 18	138	160	2835	8
110 x 80 x 110	326	71	143	181	81	200	20	8 x 18	138	160	3560	6
110 x 100 x 110	326	71	143	181	81	220	22	8 x 18	158	180	4240	6
125 x 80 x 125	382	86	165	190	88	200	20	8 x 18	138	160	4550	4
125 x 100 x 125	382	86	165	190	88	220	22	8 x 18	158	180	5180	3
160 x 80 x 160	440	86	208	210	106	200	20	8 x 18	138	160	6245	3
160 x 100 x 160	440	86	208	210	106	220	22	8 x 18	158	180	6785	3
180 x 80 x 180	422	106	245	225	116	200	20	8 x 18	138	160	7745	2
180 x 100 x 180	422	106	245	225	116	220	22	8 x 18	158	180	8550	1
200 x 80 x 200	451	114	261	240	125	200	20	8 x 18	138	160	8510	1
200 x 100 x 200	451	114	261	245	125	220	22	8 x 18	158	180	9230	1
225 x 80 x 225	494	122	293	255	140	200	20	8 x 18	138	160	11240	1
225 x 100 x 225	494	122	293	260	140	220	22	8 x 18	158	180	11900	1
250 x 80 x 250	538	129	326	270	152	200	20	8 x 18	138	160	14750	1
250 x 100 x 250	538	129	326	275	152	220	22	8 x 18	158	180	15400	1

Elbow 90°

Codo 90°

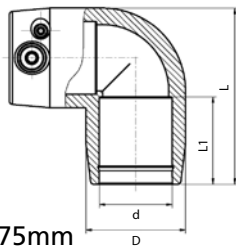

20mm up to 75mm

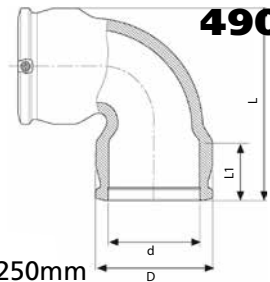

90mm up to 250mm

490504

Size d	L	L1	D	A	W	UC
20	66	35	36	38	65	320
25	66	37	36	38	52	320
32	83	40	44	43	84	192
40	92	44	55	47	137	120
50	108	48	68	52	211	72
63	131	57	81	59	319	40
75	158	69	97	62	527	33
90	213	78	113	69	875	16
110	243	79	143	79	1519	9
125	271	100	165	89	2424	6
140	309	93	183	94	3024	4
160	323	87	209	106	3990	3
180	412	105	244	115	7590	2
200	449	112	262	124	8670	1
225	498	121	295	140	9900	1
250	550	130	327	152	13500	1

Elbow 45°

Codo 45°

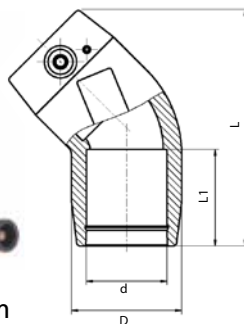

32mm up to 75mm

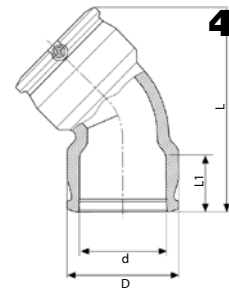

90mm up to 250mm

490604

Size d	L	L1	D	A	W	UC
32	95	39	45	43	75	240
40	108	42	55	46	117	160
50	125	49	68	51	181	96
63	148	57	81	59	264	60
75	180	71	96	62	426	40
90	243	75	112	69	759	22
110	272	78	143	78	1269	12
125	304	86	165	88	2030	8
140	342	92	182	95	2471	5
160	350	95	209	105	3990	4
180	434	105	244	114	6150	2
200	472	112	261	125	7050	1
225	520	120	294	140	9800	1
250	571	129	326	151	13400	1

Elbow 22.5°

Codo 22.5°

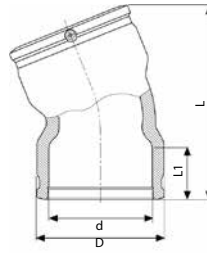

490804

Size d	L	L1	D	A	W	UC
90	214	72	113	71	665	22
110	232	71	143	81	1087	14
125	274	86	165	88	1850	8
160	302	86	209	106	2930	4
180	391	105	244	115	5360	2

LightFit Elbow 45°

Codo LightFit 45°

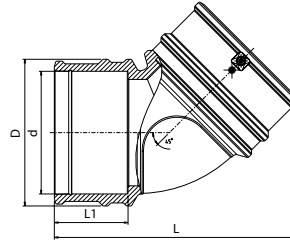

46060

Size d	L	L1	D	A	W	UC
160	323	98	193	106	1976	-

LightFit Elbow 30°

Codo LightFit 30°

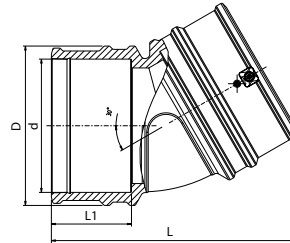

46330

Size d	L	L1	D	A	W	UC
160	300	98	193	106	1798	-

LightFit Elbow 15°

Codo LightFit 15°

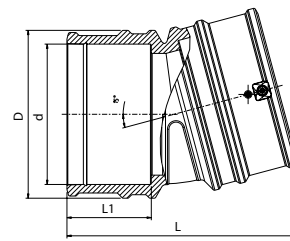

46370

Size d	L	L1	D	A	W	UC
160	265	98	193	106	1728	-

Elbow 180°

490904

Codo 180°

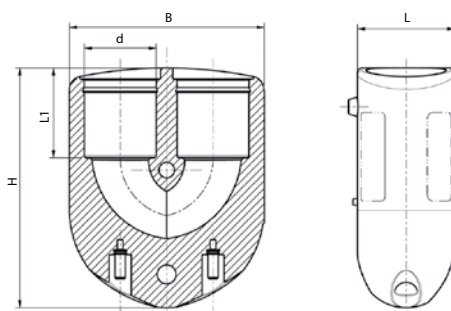

Size d	L	L1	D	A	W	UC
25	38	38	38	32	163	216
32	44	41	44	41	216	144
40	53	48	53	48	323	80

Y Reducer

491904

Y Reductor

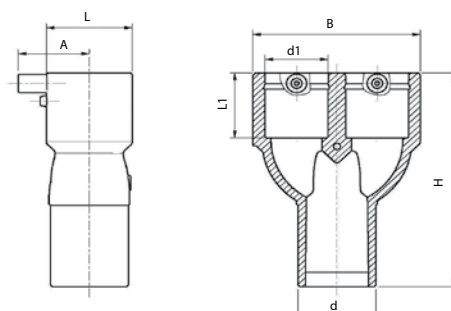

Size d x d1 x d1	L	L1	B	A	H	W	UC
32 x 25 x 25	36	40	70	38	119	97	200
40 x 32 x 32	45	43	88	42	133	151	120
50 x 40 x 40	56	46	109	46	151	242	72

Duckfoot Elbow 90°

491504

Codo 90° Empotrable

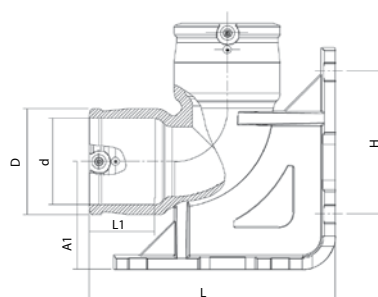

Size d	L	L1	D	A	A1	H	W	UC
90	261	69	112	71	115	151	2260	5

Duckfoot Elbow 90° With Outlet

4915Q4

Codo 90° Emportable con toma de servicio

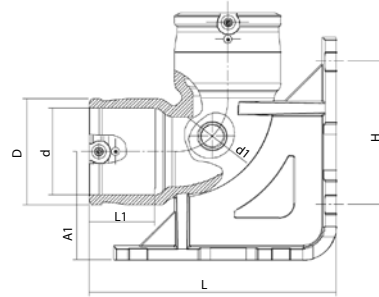

Size d x d1	L	L1	D	A	A1	H	W	UC
90 x 32	261	69	112	71	115	146	2265	5

Adjustable Elbow

4947C4

Codo Ajustable

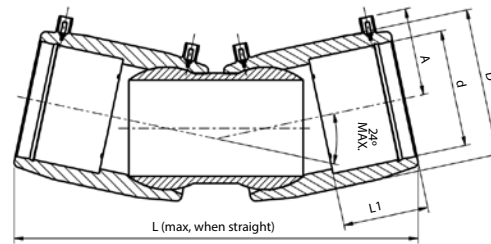

Size d	L	L1	D	A	W	UC
110	362	80	140	83	2030	8
125	382	85	157	95	2630	8
160	456	92	200	114	4510	3
180	511	104	224	128	7490	2
200	512	104	250	125	9733	-

Adjustable Elbow One Sided

4947D4

Codo Ajustable Enlace/Espiga

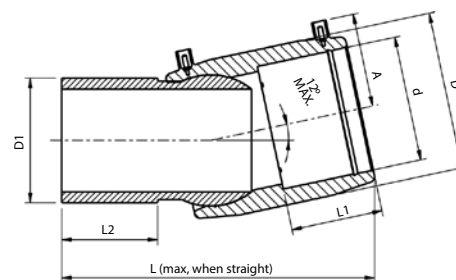

Size d x D1	L	L1	L2	D	A	W	UC
110 x 110	276	85	85	140	83	1270	12
125 x 125	292	90	90	157	95	1740	12
160 x 160	335	100	100	200	114	3150	4
180 x 180	365	138	138	223	128	4210	3
200 x 200	370	104	116	250	125	6172	-

Balloon Saddle

Collarín Globo

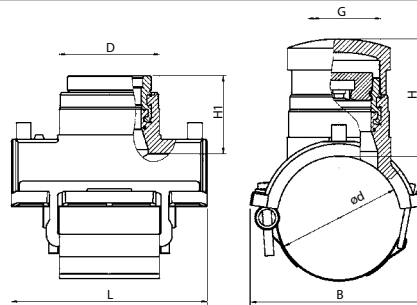

496804

Size d x G	B	H	H1	D	L	W	UC
90 x 2.1/2"	139	105	70	90	176	1961	10
110 x 2.1/2"	160	105	70	90	176	1973	10
125 x 2.1/2"	169	105	70	90	176	1981	10
140 x 2.1/2"	174	105	70	90	176	2000	10
160 x 2.1/2"	176	105	70	90	176	1984	10
180 x 2.1/2"	182	105	70	90	176	1997	10
200 x 2.1/2"	202	105	70	90	176	1991	10
225 x 2.1/2"	227	105	70	90	176	2003	10
250 x 2.1/2"	252	105	70	90	176	2010	10

Saddle BSPP Female Outlet

Collarín BSPP Rosca Hembra

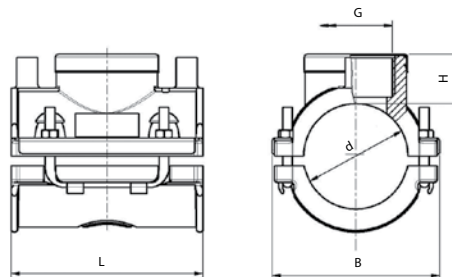

4958T

Size d x G	B	H	L	W	UC
63 x 1"	100	30	118	390	60
63 x 1.1/4"	100	30	118	400	60
63 x 1.1/2"	100	30	118	400	60

Repair Saddle

Toma de Reparación

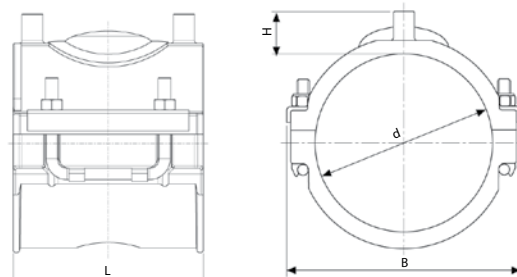

495204

Size d	B	H	L	W	UC
63	103	29	118	378	72
75	117	29	118	410	56
90	124	29	118	504	40
110	145	29	118	555	32
125	162	29	118	620	24
140	178	29	118	660	24
160	199	29	118	718	24
180	219	29	118	759	16

Transition Saddle

Collarín de Transición

493804



63mm up to 180mm
Outlets 1¼" and 1½"



90mm up to 250mm
Outlet 2"

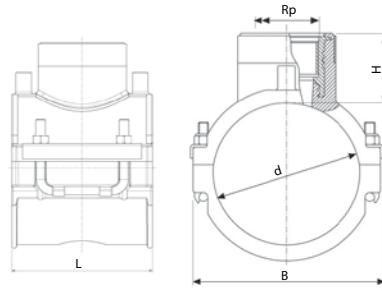

Size d x Rp	B	H	L	W	UC
63 x 1.1/4"	100	53	118	612	48
75 x 1.1/4"	117	53	118	605	40
90 x 1.1/2"	126	53	118	930	16
90 x 2"	142	76	176	1493	14
110 x 1.1/2"	142	53	118	1000	12
110 x 2"	158	76	176	1500	12
125 x 1.1/2"	158	53	118	1049	12
125 x 2"	166	76	176	1510	12
140 x 1.1/2"	175	53	118	1072	10
140 x 2"	174	76	176	1520	10
160 x 1.1/2"	196	53	118	1163	8
160 x 2"	176	76	176	1540	8
180 x 1.1/2"	216	53	118	1200	6
180 x 2"	182	76	176	1500	10
200 x 2"	202	76	176	1575	10
225 x 2"	227	76	176	1570	10
250 x 2"	252	76	176	1546	10

NEW!

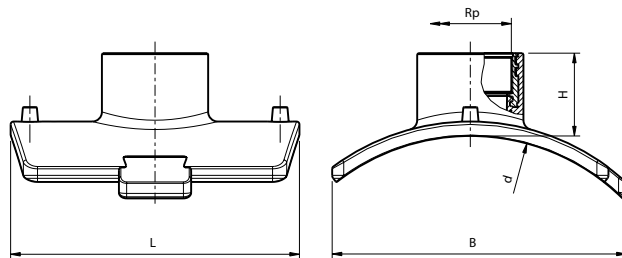

Size d x Rp	B	H	L	W	UC
280-400 x 2"	300	77	306	1975	8
450-710 x 2"	300	77	314	-	-

* See dedicated tools on page 55

Monolithic Weld End Cap for Balloon Saddle

498304

Tapón Monolítico Soldable para collarín globo

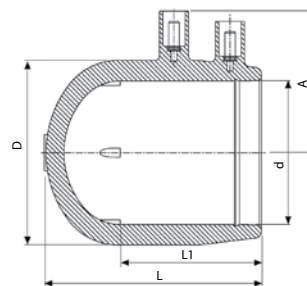

Size d	L	L1	D	A	W	UC
90	123	77	117	77	479	55

Branch Saddle

Collarín de Derivación

495804



63mm up to 180mm
Outlets 32mm to 63mm



200mm up to 315mm
and all sizes with Outlet 90mm

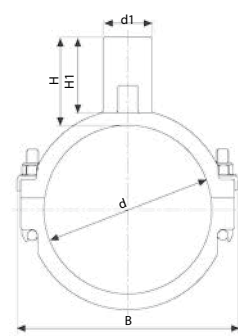
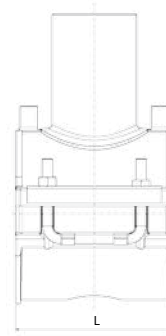

Size d x d1	B	H	H1	L	Max Cutting Dia	W	UC
63 x 32	100	59	49	118	23.0	394	56
63 x 40	100	78	66	118	29.5	400	40
63 x 50	100	93	82	118	37.5	430	40
63 x 63	100	94	85	118	45.0	462	40
75 x 32	117	59	49	118	23.0	438	48
75 x 40	117	78	66	118	29.5	451	36
75 x 50	117	93	82	118	37.5	465	32
75 x 63	117	94	85	118	45.0	522	32
90 x 32	126	59	49	118	23.0	519	32
90 x 40	126	78	68	118	29.5	529	32
90 x 50	126	93	82	118	37.5	550	32
90 x 63	126	94	85	118	45.0	608	24
90 x 90	139	105	90	176	66.0	934	15
110 x 32	148	59	49	118	23.0	585	24
110 x 40	148	78	68	118	29.5	598	24
110 x 50	148	93	82	118	37.5	629	20
110 x 63	148	94	85	118	45.0	658	20
110 x 90	162	105	90	176	68.0	948	18
125 x 32	162	59	49	118	23.0	620	24
125 x 40	162	78	68	118	29.5	613	20
125 x 50	162	93	82	118	37.5	690	20
125 x 63	162	94	85	118	45.0	721	16
125 x 90	169	105	90	176	68.0	953	18
140 x 32	180	59	49	118	23.0	689	24
140 x 40	180	78	68	118	29.5	664	16
140 x 50	180	93	82	118	37.5	721	16
140 x 63	180	94	85	118	45.0	736	16
140 x 90	174	105	90	176	68.0	965	16
160 x 32	200	59	49	118	23.0	708	16
160 x 40	200	78	68	118	29.5	722	16
160 x 50	200	93	82	118	37.5	787	16
160 x 63	200	94	85	118	45.0	825	16
160 x 90	176	105	90	176	68.0	956	16
180 x 32	219	59	49	118	23.0	800	16
180 x 40	219	78	68	118	29.5	800	12
180 x 50	219	93	82	118	37.5	828	12
180 x 63	219	94	85	118	45.0	886	12
180 x 90	182	105	90	176	68.0	976	15
200 x 63	202	102	85	176	47.0	862	15
200 x 90	202	105	90	176	68.0	900	15
225 x 63	227	102	85	176	47.0	930	15
225 x 90	227	105	90	176	68.0	983	15
250 x 63	252	102	85	176	47.0	970	15
250 x 90	252	105	90	176	68.0	990	15

NEW!

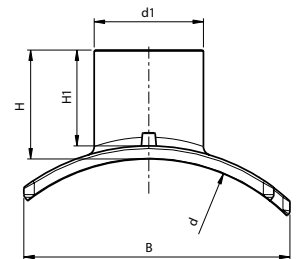
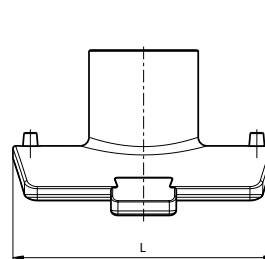

Size d x d1	B	H	H1	L	W	UC
280-400 X 90	300	117	102	306	1440	7
280-400 X 110	300	120	105	306	1540	7
280-400 X 125	300	125	110	306	1680	6
280-400 X 160	300	136	121	306	1950	6
450-710 X 90	300	117	102	314	1440	7
450-710 X 110	300	120	105	314	1540	7
450-710 X 125	300	125	110	314	1680	7
450-710 X 160	300	136	121	314	1950	6

* See dedicated tools on page 55

Tapping Saddle

496304

Toma de Servicio



40mm up to 63mm 75mm up to 180mm 200mm up to 250mm

Type	Size d x d1	H	B	H1	H2	L	Welding Cup Type	W	UC
mb	40 x 20	107	66	7	94	100	Type C	290	52
mb	40 x 32	121	66	11	94	100	Type C	370	52
mb	50 x 20	110	76	7	98	100	Type C	390	52
mb	50 x 25	91	76	10	98	100	Type C	390	50
mb	50 x 32	122	76	12	98	100	Type C	410	45
mb	63 x 20	90	100	10	90	118	Type C	355	40
mb	63 x 25	93	100	12	90	118	Type C	363	40
mb	63 x 32	99	100	12	90	118	Type C	380	40
	63 x 40	142	100	60	177	118	Type A	1080	16
	63 x 50	123	100	64	177	118	Type A	1099	16
	63 x 63	175	100	64	177	118	Type A	1183	16
	75 x 20	125	117	50	177	118	Type A	1120	16
	75 x 32	132	117	56	177	118	Type A	1091	16
	75 x 40	142	117	60	177	118	Type A	1124	16
	75 x 50	123	117	64	177	118	Type A	1139	16
	75 x 63	175	117	64	177	118	Type A	1228	16
mb	90 x 20	117	126	16	114	118	Type B	900	20
mb	90 x 25	108	126	16	114	118	Type B	1120	20
mb	90 x 32	126	126	16	114	118	Type B	1120	20
mb	90 x 40	134	126	21	114	118	Type B	1130	20
	90 x 50	123	126	64	177	118	Type A	1220	14
	90 x 63	175	126	64	177	118	Type A	1300	14
mb	110 x 20	119	148	16	114	118	Type B	964	20
mb	110 x 32	127	148	16	114	118	Type B	970	20
mb	110 x 40	138	148	21	114	118	Type B	1000	20
	110 x 50	123	148	64	177	118	Type A	1300	12
	110 x 63	175	148	64	177	118	Type A	1383	12
mb	125 x 20	116	162	16	114	118	Type B	1220	15
mb	125 x 32	131	162	16	114	118	Type B	1230	15
mb	125 x 40	141	162	21	114	118	Type B	1280	15
	125 x 50	123	162	64	177	118	Type A	1345	12
	125 x 63	175	162	64	177	118	Type A	1420	12
	140 x 32	132	180	56	177	118	Type A	1330	12
	140 x 40	142	180	60	177	118	Type A	1360	12
	140 x 50	123	180	64	177	118	Type A	1382	12
	140 x 63	175	180	64	177	118	Type A	1468	12
mb	160 x 20	118	199	21	138	118	Type A	1360	10
mb	160 x 32	144	199	16	138	118	Type A	1320	10
mb	160 x 40	157	199	21	138	118	Type A	1439	10
mb	160 x 50	175	199	24	138	118	Type A	1375	10
mb	160 x 63	197	199	20	138	118	Type A	1390	10
	180 x 20	125	219	50	177	118	Type A	1550	10
mb	180 x 32	144	219	18	138	118	Type A	1565	10
mb	180 x 40	155	219	21	138	118	Type A	1580	10
mb	180 x 50	174	219	24	138	118	Type A	1595	10
mb	180 x 63	197	219	20	138	118	Type A	1605	10
	200 x 20	125	202	50	177	176	Type A	1425	8
	200 x 32	132	202	56	177	176	Type A	1445	8
	200 x 40	142	202	60	177	176	Type A	1471	8
	200 x 50	123	202	64	177	176	Type A	1496	8
	200 x 63	175	202	64	177	176	Type A	1579	8
	225 x 20	125	227	50	177	176	Type A	1370	8
	225 x 32	132	227	56	177	176	Type A	1450	8
	225 x 40	142	227	60	177	176	Type A	1485	8
	225 x 50	123	227	64	177	176	Type A	1506	8
	225 x 63	175	227	64	177	176	Type A	1589	8
	250 x 20	125	252	50	177	176	Type A	1380	8
	250 x 32	132	252	56	177	176	Type A	1464	8
	250 x 40	142	252	60	177	176	Type A	1582	8
	250 x 50	123	252	64	177	176	Type A	1589	8
	250 x 63	175	252	64	177	176	Type A	1595	8

Please note: mb = Mono Block

Nota: mb = monobloque

Tapping Saddle parallel outlet

4963P4

Toma de Servicio salida paralela

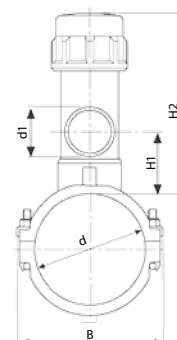
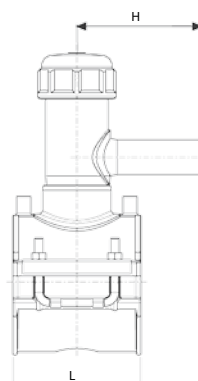

Size d x d1	H	B	H1	H2	L	Welding Cup Type	W	UC
63 x 20	115	100	65	177	118	Type A	1035	16
63 x 32	127	100	65	177	118	Type A	1042	16
63 x 40	148	100	65	177	118	Type A	1070	16
63 x 50	141	100	65	177	118	Type A	1094	16
63 x 63	178	100	65	177	118	Type A	1180	16
75 x 20	115	117	65	177	118	Type A	1120	16
75 x 32	127	117	65	177	118	Type A	1130	16
75 x 40	148	117	65	177	118	Type A	1119	16
75 x 50	141	117	65	177	118	Type A	1140	16
75 x 63	178	117	65	177	118	Type A	1226	16
90 x 20	115	126	65	177	118	Type A	1170	14
90 x 32	127	126	65	177	118	Type A	1120	14
90 x 40	148	126	65	177	118	Type A	1130	14
90 x 50	141	126	65	177	118	Type A	1235	14
90 x 63	178	126	65	177	118	Type A	1270	14
110 x 20	115	148	65	177	118	Type A	1240	12
110 x 32	127	148	65	177	118	Type A	1175	12
110 x 40	148	148	65	177	118	Type A	1179	12
110 x 50	141	148	65	177	118	Type A	1293	12
110 x 63	178	148	65	177	118	Type A	1380	12
125 x 20	115	162	65	177	118	Type A	1275	10
125 x 32	127	162	65	177	118	Type A	1298	10
125 x 40	148	162	65	177	118	Type A	1320	10
125 x 50	141	162	65	177	118	Type A	1335	10
125 x 63	178	162	65	177	118	Type A	1426	10
140 x 32	127	180	65	177	118	Type A	1330	10
140 x 40	148	180	65	177	118	Type A	1360	10
140 x 50	141	180	65	177	118	Type A	1370	10
140 x 63	178	180	65	177	118	Type A	1468	10
160 x 20	115	199	65	177	118	Type A	1390	10
160 x 32	127	199	65	177	118	Type A	1304	10
160 x 40	148	199	65	177	118	Type A	1327	10
160 x 50	141	199	65	177	118	Type A	1348	10
160 x 63	178	199	65	177	118	Type A	1399	10
180 x 20	115	219	65	177	118	Type A	1550	8
180 x 32	127	219	65	177	118	Type A	1304	8
180 x 40	148	219	65	177	118	Type A	1490	8
180 x 50	141	219	65	177	118	Type A	1515	8
180 x 63	178	219	65	177	118	Type A	1304	8
200 x 20	115	202	65	177	176	Type A	1360	8
200 x 32	127	202	65	177	176	Type A	1451	8
200 x 40	148	202	65	177	176	Type A	1405	8
200 x 50	141	202	65	177	176	Type A	1425	8
200 x 63	178	202	65	177	176	Type A	1510	8
225 x 20	115	227	65	177	176	Type A	1370	8
225 x 32	127	227	65	177	176	Type A	1450	8
225 x 40	148	227	65	177	176	Type A	1485	8
225 x 50	141	227	65	177	176	Type A	1506	8
225 x 63	178	227	65	177	176	Type A	1586	8
250 x 20	115	252	65	177	176	Type A	1380	8
250 x 32	127	252	65	177	176	Type A	1569	8
250 x 40	148	252	65	177	176	Type A	1582	8
250 x 50	141	252	65	177	176	Type A	1589	8
250 x 63	178	252	65	177	176	Type A	1595	8

Welding Cap for Tapping Saddle

498304

Tapón Soldable para toma de servicio

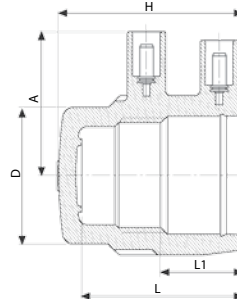

Type	Size	D	A	H	L	L1	W	UC
Type A	57	74	59	74	63	36	153	128
Type B	50	62	54	73	66	30	110	192
Type C	40	51	49	63	55	26	69	256

Please use Welding Cap Type as specified on page 21.

Utilizar el ipo de tapón soldable como se indica en la página 21.

PE Ball Valve

436207

Válvula de Bola PE

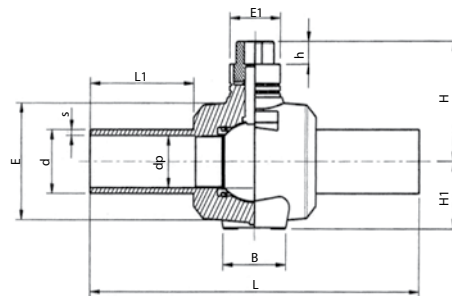

Size d	dp	s	L	L1	B	E	E1	H	H1	h	W grams	Units per carton
25*	19	3	300	103	65	80	70	94	50	40	700	4
32*	24	3.4	300	103	65	80	70	94	50	40	700	4
40	24	4.1	300	103	65	80	70	94	50	40	800	4
50*	39	6	414	130	87	120	85	160	80	40	2950	4
63*	48	6	414	130	87	120	85	160	80	40	2600	4
75	48	8	414	130	87	120	85	160	80	40	2300	4
90*	70	8.2	550	176	93	200	85	200	110	40	6700	1
110*	86	10	550	178	93	200	85	200	110	40	6700	1
125	86	12	550	182	93	200	85	200	110	40	6100	1
160	86	16	550	182	93	200	85	200	110	40	7000	1

* Full Bore Dimensions

* Dimensiones de cavidad única

Tapping Valve

495404/4954S4*

Toma de Servicio con Válvula

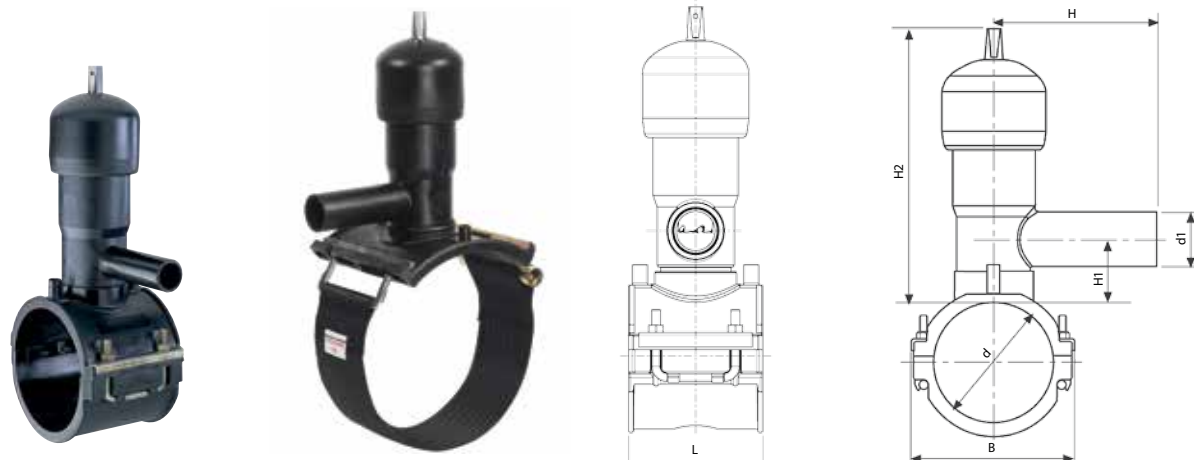

63mm up to 180mm

200mm up to 250mm

Size d x d1	B	H	H1	H2	L	W	UC
63 x 32	99	126	40	238	118	2090	8
63 x 40	99	137	40	238	118	2103	8
63 x 50	99	152	45	238	118	2140	8
63 x 63	99	186	45	238	118	2205	8
75 x 32	117	126	40	238	118	2100	8
75 x 40	117	137	40	238	118	2089	8
75 x 50	117	152	45	238	118	2089	8
75 x 63	117	186	45	238	118	2089	8
90 x 32	126	126	46	244	118	2150	8
90 x 40	126	137	46	244	118	2163	8
90 x 50	126	152	51	244	118	2200	8
90 x 63	126	186	51	244	118	2265	8
110 x 32	148	126	46	244	118	2266	8
110 x 40	148	137	46	244	118	2250	8
110 x 50	148	152	51	244	118	2279	8
110 x 63	148	186	51	244	118	2345	8
125 x 32	162	126	46	244	118	2276	8
125 x 40	162	137	46	244	118	2289	8
125 x 50	162	152	51	244	118	2326	8
125 x 63	162	186	51	244	118	2391	8
140 x 32	180	126	46	244	118	2285	8
140 x 40	180	137	46	244	118	2298	8
140 x 50	180	152	51	244	118	2335	8
140 x 63	180	186	51	244	118	2441	8
160 x 32	202	126	46	244	118	2377	8
160 x 40	202	137	46	244	118	2390	8
160 x 50	202	152	51	244	118	2427	8
160 x 63	202	186	51	244	118	2492	8
180 x 32	220	126	46	244	118	2440	8
180 x 40	220	137	46	244	118	2453	8
180 x 50	220	152	51	244	118	2490	8
180 x 63	220	186	51	244	118	2550	8
200 x 32	202	126	46	244	176	2431	8
200 x 40	202	137	46	244	176	2444	5
200 x 50	202	152	51	244	176	2481	5
200 x 63	202	186	51	244	176	2546	5
225 x 32	227	126	46	244	176	2448	5
225 x 40	227	137	46	244	176	2501	5
225 x 50	227	152	51	244	176	2538	5
225 x 63	227	186	51	244	176	2603	5
250 x 32	252	126	46	244	176	2504	5
250 x 40	252	137	46	244	176	2517	5
250 x 50	252	152	51	244	176	2554	5
250 x 63	252	186	51	244	176	2619	5

* Tapping Valve with serrated edge knife. Available in all sizes.

* Toma de servicio con bordes "dientes de sierra". Todos los tamaños.

Male Transition Coupler

492104

Enlace de Transición Macho

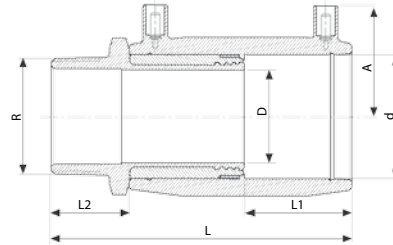

Size d x R	L	L1	L2	D	A	W	UC
20 x 1/2"	105	37	29	14	34	129	200
25 x 3/4"	111	40	29	19	37	150	150
32 x 1/2"	117	42	29	23	42	241	100
32 x 3/4"	117	42	29	23	42	263	100
32 x 1"	122	42	34	23	42	285	100
32 x 1.1/4"	124	42	36	23	42	393	60
32 x 1.1/2"	124	42	36	23	42	404	60
40 x 1"	131	47	34	29	46	409	72
40 x 1.1/4"	133	47	36	29	46	470	54
40 x 1.1/2"	133	47	36	29	46	483	54
40 x 2"	138	47	41	29	46	500	36
50 x 1"	135	49	34	38	51	513	48
50 x 1.1/4"	137	49	36	38	51	569	48
50 x 1.1/2"	137	49	36	38	51	547	48
50 x 2"	142	49	41	38	51	748	30
63 x 1.1/4"	153	57	36	48	57	884	30
63 x 1.1/2"	153	57	36	48	57	845	30
63 x 2"	158	57	41	48	57	921	30
75 x 2"	167	61	41	59	64	1305	16
75 x 2.1/2"	172	61	46	59	64	1500	16

Female Transition Coupler

493104

Enlace de Transición Hembra

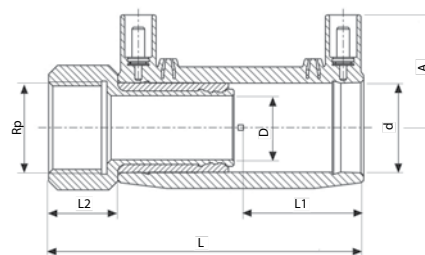

Size d x Rp	L	L1	L2	D	A	W	UC
20 x 1/2"	96	37	20	14	35	130	200
25 x 3/4"	105	40	23	19	38	145	150
32 x 3/4"	113	42	25	23	42	316	100
32 x 1"	113	42	25	23	42	265	100
32 x 1.1/2"	113	42	25	23	42	410	100
40 x 1"	122	47	25	29	46	507	54
40 x 1.1/4"	122	47	25	29	46	407	54
40 x 1.1/2"	122	47	25	29	46	419	54
50 x 1.1/2"	126	49	25	38	51	491	48
50 x 2"	131	49	30	38	51	685	40
63 x 1.1/2"	147	57	30	48	57	975	24
63 x 2"	147	57	30	48	57	879	30

Male Transition Elbow 90°

492504

Codo de Transición de 90° Macho

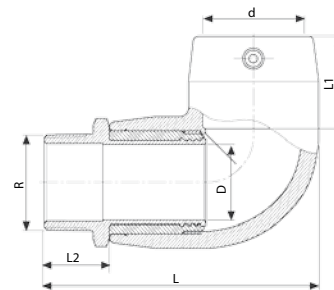

Size d x R	L	L1	L2	D	A	W	UC
20 x 1/2"	95	35	29	14	38	153	400
25 x 3/4"	95	37	29	19	38	168	120
32 x 1/2"	112	40	29	23	43	259	84
32 x 3/4"	112	40	29	23	43	262	84
32 x 1"	117	40	34	23	43	300	84
32 x 1.1/4"	119	40	36	23	43	419	60
32 x 1.1/2"	119	40	36	23	43	436	60
40 x 1"	126	44	34	29	47	458	48
40 x 1.1/4"	128	44	36	29	47	500	48
40 x 1.1/2"	128	44	36	29	47	510	48
40 x 2"	133	44	41	29	47	725	40
50 x 1"	142	48	34	38	52	624	42
50 x 1.1/4"	144	48	36	38	52	679	36
50 x 1.1/2"	144	48	36	38	52	655	36
50 x 2"	149	48	41	38	52	806	30
63 x 1.1/4"	167	57	36	48	59	985	24
63 x 1.1/2"	167	57	36	48	59	1040	24
63 x 2"	172	57	41	48	59	1125	24
75 x 2"	199	69	41	59	62	1450	16
75 x 2.1/2"	204	69	46	59	62	1649	16

Female Transition Elbow 90°

493504

Codo de Transición de 90° Hembra

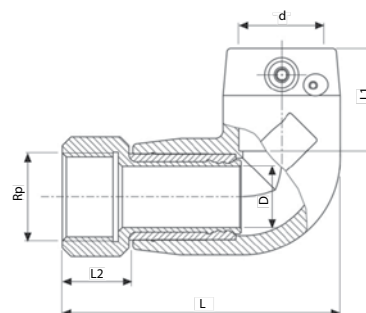

Size d x Rp	L	L1	L2	D	A	W	UC
20 x 1/2"	86	35	20	14	38	142	400
25 x 3/4"	89	37	23	19	38	160	120
32 x 3/4"	108	40	25	23	43	280	96
32 x 1"	108	40	25	23	43	280	48
32 x 1.1/2"	108	40	25	23	43	360	96
40 x 1"	117	44	25	29	47	535	36
40 x 1.1/4"	117	44	25	29	47	432	48
40 x 1.1/2"	117	44	25	29	47	453	48
50 x 1.1/2"	133	48	25	38	52	560	40
50 x 2"	138	48	30	38	52	744	24
63 x 1.1/2"	161	57	30	48	59	1072	24
63 x 2"	161	57	30	48	59	959	24

Male Transition Elbow 45°

492604

Codo de Transición de 45° Macho

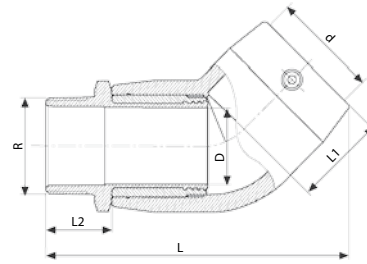

Size d x R	L	L1	L2	D	A	W	UC
32 x 1/2"	124	39	29	23	43	249	84
32 x 3/4"	123	39	29	23	43	250	84
32 x 1"	129	39	34	23	43	375	72
32 x 1.1/4"	130	39	36	23	43	479	48
32 x 1.1/2"	130	39	36	23	43	488	48
40 x 1"	142	44	34	29	47	433	60
40 x 1.1/4"	144	44	36	29	47	485	60
40 x 1.1/2"	144	44	36	29	47	510	48
40 x 1.1/4"	150	44	41	29	47	685	40
40 x 2"	149	44	34	38	47	564	48
50 x 1"	161	49	36	38	51	610	48
50 x 1.1/4"	161	49	36	38	51	600	48
50 x 1.1/2"	166	49	41	38	51	778	30
63 x 1.1/4"	184	57	36	48	59	927	24
63 x 1.1/2"	184	57	36	48	59	860	24
63 x 2"	189	57	41	48	59	953	24
75 x 2"	221	71	41	59	62	1399	16
75 x 2.1/2"	226	71	46	59	62	1600	16

Female Transition Elbow 45°

493604

Codo de Transición de 45° Hembra

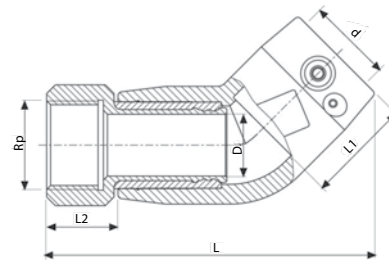

Size d x Rp	L	L1	L2	D	A	W	UC
32 x 1"	120	39	25	23	43	342	96
32 x 1.1/2"	120	39	25	23	43	488	96
40 x 1"	133	44	25	29	47	510	48
40 x 1.1/4"	133	44	25	29	47	419	48
40 x 1.1/2"	133	44	25	29	47	479	48
50 x 1.1/2"	150	49	25	38	51	532	48
50 x 2"	155	49	30	38	51	714	48
63 x 1.1/2"	178	57	30	48	59	1019	24
63 x 2"	178	57	30	48	59	912	24

Male Free Nut Transition Coupler

4941M4

Enlace de Transición, Tuerca Libre, Macho

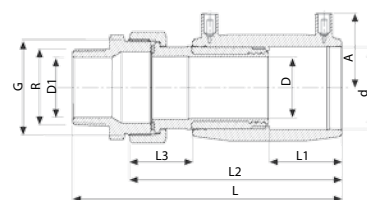

Size d x R	G	L	L1	L2	L3	D	D1	A	W	UC
32 x 1"	1.1/4"	159	42	124	34	23	24	42	555	40
40 x 1.1/4"	1.1/2"	173	47	136	38	29	30	45	779	30
50 x 1.1/2"	2"	182	49	142	41	38	38	50	1191	20
63 x 1.1/2"	2"	201	57	162	41	38	38	57	1440	16
63 x 2"	2.1/2"	210	57	167	49	48	48	57	1929	10

Female Free Nut Transition Coupler

494104

Enlace de Transición, Tuerca Libre, Hembra

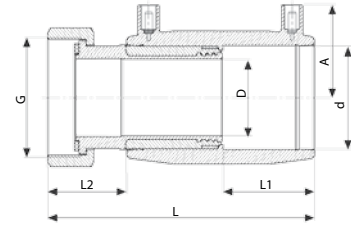

Size d x G	L	L1	L2	D	A	W	UC
20 x 3/4"	106	37	30	14	34	150	200
25 x 3/4"	112	40	30	14	37	150	140
25 x 1"	115	40	33	19	37	200	140
32 x 1"	124	42	36	19	42	260	78
32 x 1.1/4"	124	42	36	23	42	310	52
40 x 1.1/2"	135	47	38	29	45	444	32
50 x 2"	141	49	41	38	52	709	32
63 x 2"	161	57	44	38	57	770	28
63 x 2.1/2"	166	57	49	48	57	1154	20

Male Free Nut Transition Elbow 90°

4945M4

Codo de Transición de 90° Tuerca Libre, Macho

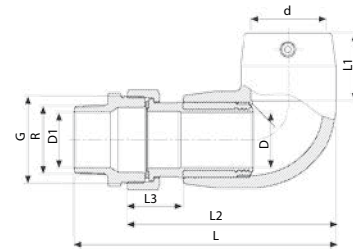

Size d x R	G	L	L1	L2	L3	D	D1	A	W	UC
32 x 1"	1.1/4"	150	40	115	36	23	24	43	574	40
40 x 1.1/4"	1.1/2"	170	44	133	40	29	30	47	810	30
50 x 1.1/2"	2"	190	48	150	41	38	38	52	1256	20
63 x 1.1/2"	2"	216	57	176	44	41	38	59	1635	16
63 x 2"	2.1/2"	224	57	181	49	48	48	59	2000	12

Female Free Nut Transition Elbow 90°

494504

Codo de Transición de 90° Tuerca Libre, Hembra

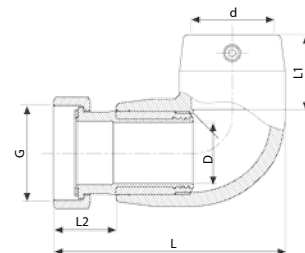

Size d x G	L	L1	L2	D	A	W	UC
20 x 3/4"	96	35	30	14	38	164	140
25 x 3/4"	96	37	30	14	38	164	140
25 x 1"	99	37	33	19	38	164	105
32 x 1"	119	40	36	19	43	164	70
32 x 1.1/4"	119	40	36	23	43	324	70
40 x 1.1/2"	132	44	40	29	47	490	48
50 x 2"	149	48	41	38	52	779	30
63 x 2"	175	57	44	41	59	1024	16
63 x 2.1/2"	180	57	49	48	59	1245	18

Male Free Nut Transition Elbow 45°

4946M4

Codo de Transición de 45° Tuerca Libre, Macho

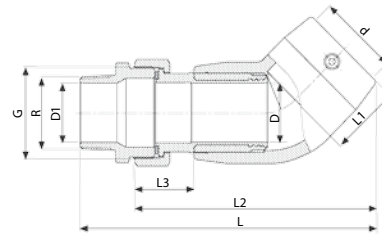

Size d x R	G	L	L1	L2	L3	D	D1	A	W	UC
32 x 1"	1.1/4"	164	39	129	34	23	24	47	645	40
40 x 1.1/4"	2.1/2"	189	44	147	44	29	30	47	790	30
50 x 1.1/2"	2"	206	49	165	41	38	38	51	1232	20
63 x 1.1/2"	2"	231	57	193	58	41	38	59	1489	16
63 x 2"	2.1/2"	240	57	198	49	48	48	59	1945	12

Female Free Nut Transition Elbow 45°

494604

Codo de Transición de 45° Tuerca Libre, Hembra

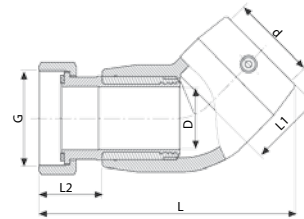

Size d x G	L	L1	L2	D	A	W	UC
32 x 1"	131	39	36	19	43	164	70
32 x 1.1/4"	129	39	34	23	47	400	56
40 x 1.1/2"	146	44	38	29	47	469	48
50 x 2"	166	49	41	38	51	740	30
63 x 2"	189	57	41	38	59	950	18
63 x 2.1/2"	197	57	44	48	59	1184	18

Female Union Free Nut Transition Tee

494404

Enlace T, PE/Latón, Tuerca Libre, Hembra

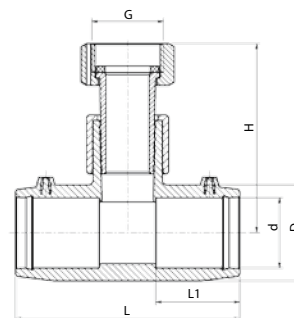

Size d x G	L	L1	D	H	A	W	UC
32 x 1"	104	39	44	88	43	320	50

PE Male Transition Coupler

497104

Enlace de Transición PE Macho

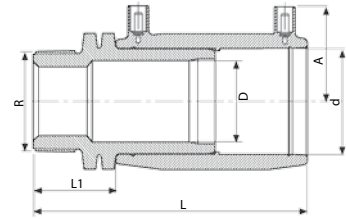

Size d x R	D	L	L1	W	UC
20 x 1/2"	14	97	21	129	200
25 x 3/4"	18	113	31	61	200
32 x 1"	24	123	35	92	200
40 x 1"	30	134	37	146	144
40 x 1.1/4"	30	137	40	152	144
40 x 1.1/2"	30	137	40	159	144
50 x 1.1/2"	38	141	40	238	96
63 x 1.1/2"	48	161	44	371	40
63 x 2"	48	165	48	450	40

PE Male Transition Elbow 90°

497504

Codo de Transición PE de 90° Macho

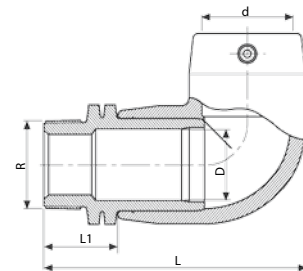

Size d x R	A	D	L	L1	W	UC
20 x 1/2"	38	14	87	21	458	200
25 x 3/4"	38	18	97	31	77	200
32 x 1"	43	24	118	35	120	96
40 x 1"	47	30	129	37	187	48
40 x 1.1/4"	47	30	132	40	202	48
40 x 1.1/2"	47	30	132	40	250	48
50 x 1.1/2"	52	38	148	40	296	48
63 x 1.1/2"	59	48	175	44	458	24
63 x 2"	59	48	179	48	471	32

PE Male Transition Elbow 45°

497604

Codo de Transición PE de 45° Macho

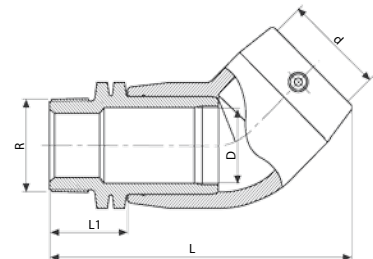

Size d x R	D	L	L1	W	UC
32 x 1"	24	141	35	150	96
40 x 1"	30	145	37	175	96
40 x 1.1/4"	30	148	40	185	96
40 x 1.1/2"	30	148	40	185	96
50 x 1.1/2"	38	165	49	271	48
63 x 1.1/2"	48	192	44	465	24
63 x 2"	48	196	48	470	32

PE Cast Iron Flange Transition Coupler

497704

Enlace de Transición Bridado - PE Hierro Fundido

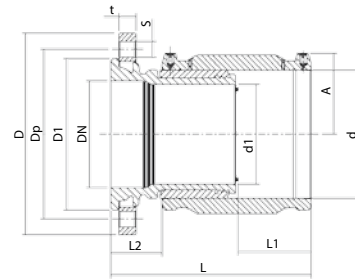

Size d x DN	A	L	L1	L2	D1	d1	D	Dp	s	t	No. of holes	W grams	UC
63 x 50	57	217	57	100	104	43	165	125	18	20	4	4200	4
90 x 80	70	216	73	68	139	67	200	160	18	20	8	5940	4
110 x 100	79	223	80	61	159	84	220	180	18	22	8	7280	4
125 x 100	87	235	85	62	159	98	220	180	18	22	8	7759	4
160 x 150	105	268	93	73	215	125	285	240	22	24	8	13400	1
180 x 150	116	284	105	72	215	140	285	240	22	24	8	15246	1
225 x 200	138	314	119	74	270	176	340	295	22	26	8	23919	1

PE Cast Iron Spigot Transition Coupler

495704

Enlace de Transición Espiga - PE Hierro Fundido

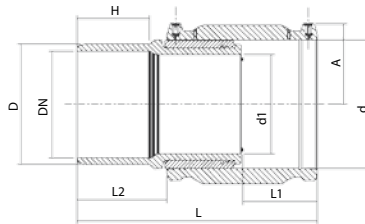

Size d x DN	A	L	L1	L2	D	d1	H	W grams	UC
90 x 80	69	254	73	106	98	67	94	2874	64
110 x 100	79	275	80	112	118	84	96	4170	32
125 x 100	87	280	85	107	118	98	91	4569	16
160 x 150	104	322	97	124	170	125	102	8105	16
180 x 150	114	339	104	127	170	140	103	10121	16
225 x 200	140	372	118	132	222	176	109	12284	16

Full Face Flange

490209

Brida de Cara Plana

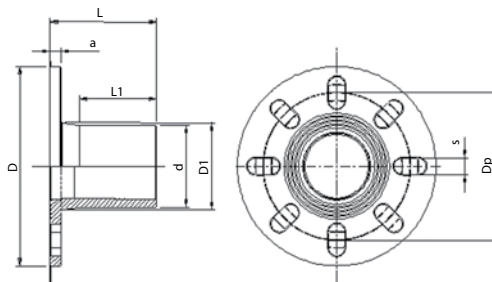

Size d	L	L1	D	D1	a	Dp	s	W	UC
90	118	86	220	98	12	163	20	995	18

Stub Flange

490207

Adaptador de Brida

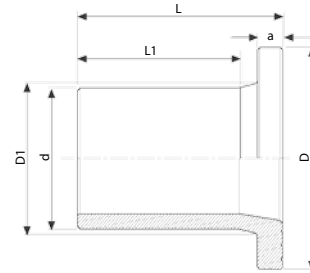

Maximum Pressure: (cold water) up to 180mm PN16 From 200mmPN 12.5
 Presión máxima: PN (agua fría) up to 180mm PN16 From 200mmPN 12.5

Size d	L	L1	a	D	D1	W	UC
20	85	45	7	45	26	26	160
25	85	40	9	58	32	42	160
32	85	60	10	68	40	57	144
40	85	60	11	78	50	84	80
50	104	75	12	88	61	132	48
63	120	87	14	102	75	220	32
75	130	92	16	122	89	322	24
90	140	96	17	138	105	475	16
110	160	110	18	158	125	747	24
125	182	132	25	158	132	945	10
140	180	130	25	188	155	1290	6
160	180	130	25	212	175	1600	4
180	198	140	30	212	187	1990	4
200	200	135	32	268	232	3100	6
225	200	135	32	268	235	3360	4
250	215	145	35	320	285	5080	3
280	228	160	35	320	291	5625	1
315	238	160	35	370	335	7470	1
355	255	175	40	430	373	10475	1
400	286	195	45	482	427	14970	1

Flange Backing Ring

09903

Brida Revestida

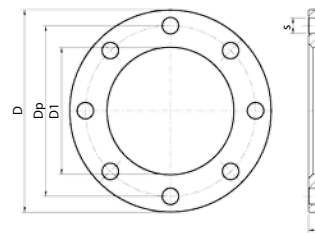

Flange	D	Dp	D1	s	t	No. Holes
20 x 1/2"	95	65	28	14	12	4
25 x 3/4"	105	75	34	14	14	4
32 x 1"	115	85	42	14	16	4
40 x 1.1/4"	140	100	51	18	18	4
50 x 1.1/2"	150	110	62	18	18	4
63 x 2"	165	125	78	18	18	4
75 x 2.1/2"	185	145	92	18	20	4
90 x 2.1/2"	185	145	102	18	20	8
90 x 3"	200	160	108	18	20	8
110 x 4"	220	180	128	18	22	8
125 x 4"	220	180	135	18	22	8
140 x 5"	250	210	158	18	22	8
160 x 6"	285	240	178	22	24	8
180 x 6"	285	240	188	22	24	8
200 x 8"	340	295	235	22	24	8
225 x 8"	340	295	238	22	24	8
250 x 10"	395	350	288	22	26	12
250 x 10" BS	395	355	288	22	26	8
280 x 10"	395	350	294	22	26	12
280 x 10" BS	395	355	294	22	26	8
315 x 12"	445	400	338	22	26	12
315 x 12" BS	445	406	338	22	26	12
355 x 14" BS	520	470	376	26	28	12

Wastewater System

We Make the Connection

Polyethylene offers the ideal cost-effective and technically superior alternative to other materials, requiring minimal effort to install, reducing the number of connections required and increasing the system lifespan.

The Plasson System constitutes an excellent investment for both public wastewater infrastructures and private wastewater systems.

The Plasson wastewater system offers a strong, long-life and is resistant to axial loads through its special versatile products that can be completely fused after being laid.



Systemas de Aguas Residuales

Hacemos la Conexión

En comparación con otros materiales, el polietileno constituye la alternativa ideal en términos de costo-beneficio y superioridad técnica, ya que requiere un mínimo esfuerzo de instalación, con menos conexiones, y asegura una larga vida útil. El sistema de Plasson es una inversión excelente, tanto para las infraestructuras públicas de aguas residuales como para los sistemas privados.

Los sistemas de Plasson para aguas residuales son muy duraderos y resistentes a las cargas axiales, gracias a la versatilidad de sus productos que pueden fusionarse completamente después de la instalación.

Wastewater Adjustable Saddle

475804

Ramal Para Aguas Residuales

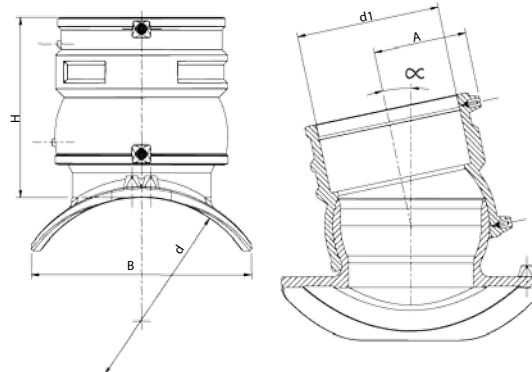

Size d x d1	B	H	A	L	W	UC
200 x 160	208	202	105	Max. 12°	2050	4
225 - 250 x 160	225	202	105	Max. 12°	2010	4
280 - 315 x 160	247	202	105	Max. 12°	2070	4
355 - 560 x 160	263	202	105	Max. 12°	2080	4

Wastewater Saddle 45° - Inlet 110

4758A4

Ramal 45° de Salida Para Aguas Residuales

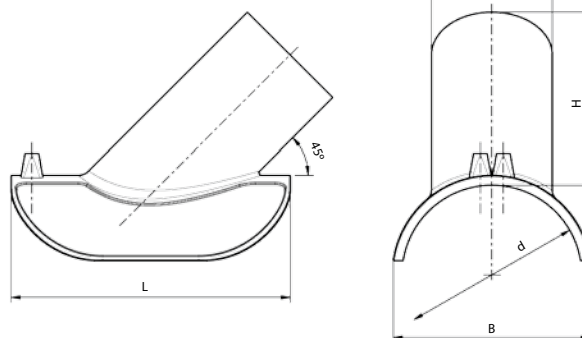

Size d x d1	L	B	H	W	UC
160 - 200 x 110	255	182	158	685	10
225 - 315 x 110	255	221	158	710	10

Wastewater Saddle PVC/PP Adaptor Inlet

4758V4

Collarín lightfit de transición para aguas residuales de PE A PP/PVC

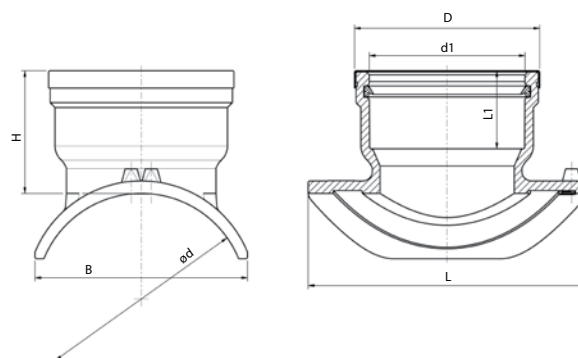

Size d x d1	B	H	L	L1	D	W	UC
200 x 160	208	125	290	80	190	1660	4
225 - 250 x 160	225	125	290	80	190	1309	4
280 - 315 x 160	247	125	290	80	190	1326	4
355 - 560 x 160	263	125	290	80	190	1430	4

Wastewater Saddle Spigot Inlet

4758S4

Collarín lightfit para aguas residuales con salida espiga

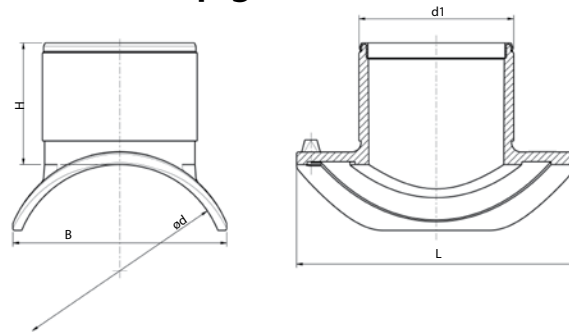

Size d x d1	B	H	L	W	UC
200 X 160	208	125	290	1091	4
225 - 250 x 160	225	125	290	1239	4
280 - 315 x 160	247	125	290	1260	4
355 - 560 x 160	263	125	290	1300	4

Wastewater Adjustable Elbow One Sided

4747D4

Codo Ajustable Para Aguas Residuales

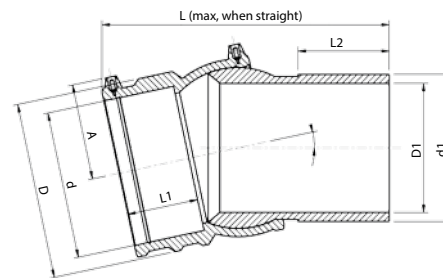

Size d	SDR	D	D1	L	L1	L2	A	W	UC
160	17	193	141	298	78	98	105	3030	6

Wastewater Manhole Adaptor

37020/477207*

Adaptador Para Pozo de Aguas Residuales

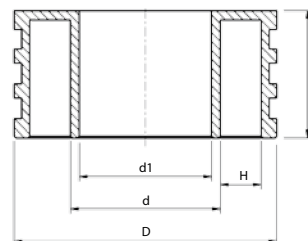

Size d	L	d1	D	H	W	UC
110	135	97	216	37	1650	-
125	135	111	235	39	1800	-
140	135	123	254	39	1950	-
160*	135	141	280	39	2524	6
180	135	157	335	66	3550	4
200	135	176	355	56	3660	2
225*	135	198	355	44	3902	2
250	135	220	400	54	3740	2
280*	135	247	400	39	5027	2
315	135	278	450	46	5130	2
355	135	313	500	50	6480	2
400	135	353	560	59	8260	1
450	135	397	592	50	22350	-
500	135	441	651	54	23600	-
560	135	494	705	51	34500	-

Wastewater PE to PVC Adaptor

4701V4

Adaptador Para PE A PVC

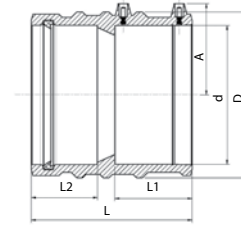

Size d	L	L1	L2	D	A	W	UC
160	187	90	77	193	106	-	-

Wastewater Adjustable Elbow PE to PVC

4747V4

Codo Ajustable de Transición de PE a PVC

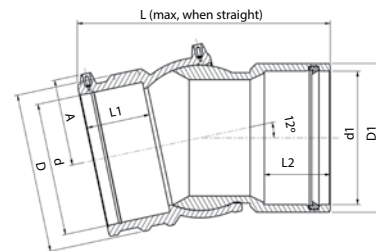

Size d x d1	D	D1	L	L1	L2	A	W	UC
160 X 160	193	180	253	78	80	105	2140	-

Wastewater Adaptor for Clay Pipe

37980

Adaptador Para Tubería Cerámica

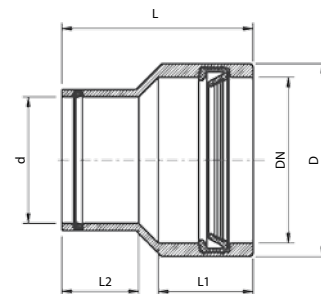

Size d x DN	D	L	L1	L2	W	UC
160 X 186	227	236	121	98	1072	-
160 X 204	249	245	121	98	1087	-

Wastewater Spigot Adaptor for Clay Pipe

37117

Adaptador Espiga Para Tubería Cerámica

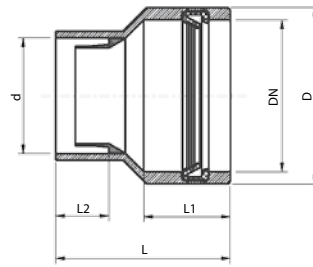

Size d x DN	D	L	L1	L2	W	UC
160 X 186	227	248	121	74	1067	-
160 X 204	249	248	121	74	1085	-

Wastewater Elbow 45°

470604

Codo 45° Para Aguas Residuales

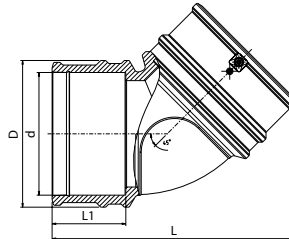

Size d	L	L1	D	A	W	UC
160	325	98	193	106	2000	-

Wastewater Elbow 30°

473304

Codo 30° Para Aguas Residuales

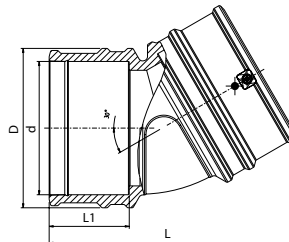

Size d	L	L1	D	A	W	UC
160	302	98	193	106	1850	-

Wastewater Elbow 15°

473704

Codo 15° Para Aguas Residuales

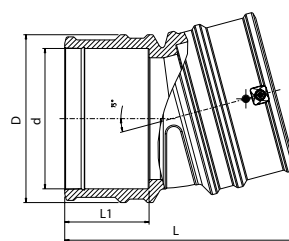

Size d	L	L1	D	A	W	UC
160	267	98	193	106	1740	-

Technical Specifications for Plasson ElectroFusion Fittings

Pressure Rating

All Plasson ElectroFusion Fittings are rated:

- PN 16 (Water)
- MOP10 (Gas)

Lightfit (Page 9) are rated:

- PN10 (Water)

Note: for further details, see the notations on each fitting or consult your Plasson representative

Suitable Pipes - PE80, PE100 PEX (most fittings)*

Plasson's ElectroFusion Fittings:

- Up to 75mm (Inclusive) are Weldable to Pipes SDR \leq 11
- 90mm & Up are Weldable to Pipes SDR \leq 17

Note: for tapping SDR \leq 11 pipes (200mm & up), please consult your Plasson representative

*Please consult your Plasson representative

LightFit:

- 90mm are Weldable to Pipes SDR \leq 26
- 110mm - 800mm are Weldable to Pipes SDR \leq 33

Wastewater Saddle:

- 200 mm & Up are Weldable to Pipes SDR \leq 26

Wastewater Adjustable Elbow:

- 160 mm is Weldable to Pipes SDR \leq 17

Abbreviations used on the product description pages of this catalog:

A, A1	Height of shroud from centerline	L, L1, L2	Length
d, d1	Nominal diameter of fitting or outlet	n	Number of bolt holes in flanges
D, D1	Diameter	S	Diameter of bolt holes in flanges
DN	Nominal bore corresponding approximately to the inside diameter of the pipe	t	Thickness of metal flange
Dp	Pitch circle diameter of bolt holes in flanges	W	Weight in grams
G, R, Rp	Threaded outlet diameter	UC	Units per carton
H	Height		

Fusion and cooling time are specified on the individual product.

Whereas the products shown in this catalogue illustrate and describe the current state of their development, Plasson reserves the right at all times to make such technical alterations as it shall see fit to its products. Although every care has been taken in the preparation of the information, specifications and other data included in this catalogue, we cannot rule out inadvertent errors or omissions. Purchasers should take into account possible deviations or variations which will not substantially diminish the functionality or performance of the products, and, in many cases, are designed to improve the same.

Plasson® is the Registered Trademark of Plasson Ltd. or Plasson Maagan Michael Industries Ltd.
Plasson's products are protected by patents, trademark, design and copyright laws.

Material

All Plasson ElectroFusion fittings are produced from material class PE100 which conform to international standards for potable water and natural or suitable manufactured gas systems.

Production from PE80, available upon request

Standards

Plasson ElectroFusion fittings are designed, tested and quality controlled according to Plasson's internal standards. These standards are based on the following international standards:

EN 1555

EN 12201

NF 136

AS/NZS 4129

WIS 4-32-14

WIS 4-32-15

Quality

Plasson has incorporated a quality assurance system in accordance with ISO 9001. Operating approval according to ISO 9001 was granted to Plasson by the Israeli Standard Institute. Operating according to the ISO 9001 quality assurance system imposes stringent standards of control throughout the manufacturing processes.

Especificaciones técnicas para los accesorios ElectroFusion de Plasson

Presiones nominales

Las presiones nominales de todos los accesorios ElectroFusion de PLASSON son las siguientes:

- PN 16 (Agua)
- MOP10 (Gas)

Accesorios LIGHTFIT (Página 9):

- PN10 (Agua)

Nota: para obtener más información, vea las indicaciones en cada accesorio o consulte a su representante de Plasson.

Compatibilidad con la tubería - PE80, PE100 PEX (la mayoría de los accesorios)*

Los accesorios ElectroFusion de PLASSON se pueden soldar:

- Hasta 75mm (inclusive), en tuberías SDR ≤ 11
- De 90mm en adelante, en tuberías SDR ≤ 17

Nota: para soldar en tuberías SDR ≤ 11 (200mm en adelante), consulte a su representante de Plasson.

*Consulte a su representante de Plasson

LightFit:

- 90mm en tuberías SDR ≤ 26
- 110mm - 800mm en tuberías SDR ≤ 33

Collarín para aguas residuales:

- De 200 mm en adelante en tuberías SDR ≤ 26

Codo ajustable para aguas residuales:

- 160 mm en tuberías SDR ≤ 17

Abreviaturas utilizadas en la descripción de productos de este catálogo:

A, A1	Altura desde la línea central a la cubierta del resistor
d, d1	Diámetro nominal del accesorio o salida
D, D1	Diámetro
DN	Diámetro nominal interno, correspondiente aproximadamente al diámetro interno del tubo
Dp	Diámetro de los orificios en las bridas
G, R, Rp	Diámetro de la salida roscada
H	Altura

Material

Todos los accesorios ElectroFusion de Plasson se fabrican con material de clase PE100, de conformidad con las normas internacionales para sistemas de agua potable y gas natural o procesado.

Accesorios de PE80, disponibles a petición del cliente.

Normativa

El diseño, las pruebas y el control de calidad de los accesorios ElectroFusion de Plasson se llevan a cabo de acuerdo con las normas internas de Plasson, basadas en las siguientes normativas internacionales:

- EN 1555
- EN 12201
- NF 136
- AS/NZS 4129
- WIS 4-32-14
- WIS 4-32-15

Aseguramiento de Calidad

Plasson utiliza el sistema de aseguramiento de calidad conforme a la normativa ISO 9001. La certificación de la empresa de acuerdo con ISO 9001 le fue otorgada a Plasson por el Instituto Israelí de Normas Industriales. La operación conforme a la normativa

de aseguramiento de calidad ISO 9001 impone estrictos procedimientos de control durante todos los procesos de fabricación.

L, L1, L2	Longitud
n	Número de orificios en las bridas
S	Diámetro de los orificios p/tornillos en las bridas
t	Grosor de la brida metálica
W	Peso en gramos
UC	Cantidad por caja de cartón

Los tiempos de soldadura y enfriamiento se indican en cada producto.

Si bien en este catálogo se ilustran y describen los productos en el estado actual de su desarrollo, PLASSON se reserva el derecho de introducir en cualquier momento las modificaciones técnicas que considere convenientes.

La preparación de la información, especificaciones y otros datos se ha hecho con el mayor cuidado, no obstante lo cual no podemos asegurar que estén libres de errores u omisiones involuntarios. El cliente debe tener en cuenta la posibilidad de desviaciones o variaciones que no afectarán significativamente el funcionamiento o rendimiento de los productos y que, en muchos casos, están destinadas a mejorarlos.

Plasson™ es la marca registrada de Plasson Ltd. o Plasson Maagan Michael Industries Ltd.

Los productos de Plasson están protegidos por derechos de patente, marcas comerciales, diseño y leyes de copyright.



The Smart System-Plasson ElectroFusion

Plasson offers quality tools and control boxes ensuring easy installation and safe, dependable connections. All Plasson products combine to form the latest state-of-the-art high performance pipe joining solution. Plasson fittings include an automatic recognition system which is part of the complete smart system. The entire ElectroFusion process is executed and fully monitored by the computerized control box.

Plasson ElectroFusion fittings can be used with Plasson's computerized smart-system control box or with standard barcode systems.

Each Plasson ElectroFusion fitting comes complete with a barcode.

Plasson provides superior products and unmatched service based on over 40 years in the field.

For our complete tooling range please ask your local Plasson representative.

Controllers

PLASSON Control Box product family includes the following features:

- Automatic (Smart-System) welding for PLASSON ElectroFusion couplings up to 12 IPS
- Ergonomic design
- Fusion process supervision system
- Fully monitored welding process
- 4 x 20 alphanumeric character display with backlight and adjustable contrast
- Easy end user oriented data input
- Highly flexible welding cable
- Reduced service expense by software controlled calibration
- Easy data transfer to PC printer or portable memory box

Monomatic Data (USB) SmartFuse welding device

3.0206.000

Scope of application

The electrofusion control units of type Monomatic Data (USB) are solely meant for the welding of thermoplastic pipes (e.g. made of PE-HD, PE80, PE100 or PP) when used with electrofusion fittings that have an input voltage of less than 48V. These devices are conforming to the standards DVS 2208-1 and ISO-12176-2, of which the applicable standards for the electrofusion fittings to be used are derived from.

Range of fitting dimensions

For which range of fitting dimensions an electrofusion control unit can be used depends essentially on the power consumption of the used fittings. Since the power consumption of the fittings is different for different fitting manufacturers, a general statement concerning this point cannot be made. When in doubt, each single case has to be checked separately. For electrofusion control units of type Monomatic Data (USB) the following general statement can be made, with the assumption, that all welding processes were made one after another, i.e. that the control unit is able to cool down during the preparation time of the next fitting: Usage for dimensions from 20 to 355 mm without limitation. When working with dimensions from 400 mm on, longer cool-down times must be provided for because otherwise the device might show the "Device too hot" error message. In this case, it is necessary to let the device cool down before putting it to use again. Before processing fittings in this dimension range, you have to check that the welding current demand of the fitting does not continuously exceed the output current of the device and that the maximum output current is not exceeded. All above made statements refer to an ambient temperature of 20 °C.



Technical Data	
3_0206_000	Monomatic Data (USB)
General	
Output voltage	40 AC [V]
Data recording	Yes
Power (60 % ON time) according to ISO 12176-2	2050 W (55.9 A)
Operating temperature range	-10 to +50 [°C]
International protection	IP54
Application class	1
Conformity	CE
ISO 12176-2 Class - classification	P ₂ 3 U S ₁ F A D M
Input of welding parameters	
Barcode with reading pen (with scanner optional)	No
SmartFuse/(FUSAMATIC)	Yes
Manual input of fittingcode	No
Manual input of welding parameters	No, U _{OUT} : 8 to 48 V, t _{WELD} : 0 to 9999 s
Manual input of welding parameters	No, U _{OUT} : 48V (preset), t _{WELD} : 0 to 9999 s
Input/Mains	
Type of voltage	AC
Nominal voltage	230 [V]
Nominal voltage range (tolerance)	185 to 300 [V]
Nominal frequency	50 [Hz]
Nominal frequency range (Tolerance)	40 to 70 [Hz]
Power factor cos ϕ	0.6 to 0.9 (phase-angle control)
Nominal current	16 [A]
Power consumption	3600 [VA]
Length of cord	4.5 [m]
Plug type	Euro plug
Output	
Type of voltage	AC
Output voltage	40 [V]
Output current (max.)	110 [A]
Output current (t → ∞)	30 [A]
Output current (min.)	2 [A]
Energy adjustment	None
Welding cable length	5 [m], other lengths on request
Welding cable mounting	Fixed
Welding terminals	4,0 [mm] (optional 4,7 [mm])
Monitoring functions	
Input	Voltage, Current, Frequency
Output	Voltage, Current, Resistance, Contact, Short circuit
Other	System, Working Temperature, Service
Error messages	Plain Text, Acoustic Signal

Casing			
Material	Steel plate with plastic casing		
Display	4 x 20 Characters (alphanum.), background lighting		
Product weight (excl. welding cable)	16 [kg]		
Product weight (incl. welding cable)	18 [kg]		
Dimensions L x W x H	450 x 325 x 380 [mm]		
Data recording			
The electrofusion control unit Monomatic Data (USB) provides data recording for 250 welding cycles.			
Packaging			
Type	Flightcase		
Dimensions	500 x 420 x 385 [mm]		
Packaging weight	8 [kg]		
Transport weight	24 [kg]		
Recorded data			
General data	Time, date, report number, ambient temperature		
Fusion data	Voltage, Current, Energy, Nominal and Actual Welding Time, Mode, Resistance, Error messages with 10 voltage and current values		
Device data	Serial Number, Inventory Number, Date of last Service, Working Hours, System Configuration		
Duty cycle according to ISO 12176-2 at 30%, 60% and 100%, Test time t = 60 minutes			
Test time	Output power at U_{OUT} = 36 V	Output power at U_{OUT} = 40 V	Output current I_{OUT}
30%	2700 W	3000 W	74.1 A
60%	2050 W	2250 W	55.9 A
100%	1600 W	1800 W	44.7 A

Polymatic Plus (USB)

3.0206.103

Scope of application

The electrofusion control units of type Polymatic Plus (USB) are solely meant for the welding of thermoplastic pipes (e.g. made of PE-HD, PE80, PE100 or PP) when used with electrofusion fittings that have an input voltage of less than 48V. These devices are conforming to the standards DVS 2208-1 and ISO-12176-2, of which the applicable standards for the electrofusion fittings to be used are derived from.

Range of fitting dimensions

For which range of fitting dimensions an electrofusion control unit can be used depends essentially on the power consumption of the used fittings. Since the power consumption of the fittings is different for different fitting manufacturers, a general statement concerning this point cannot be made. When in doubt, each single case has to be checked separately. For electrofusion control units of type Polymatic Plus (USB) the following general statement can be made, with the assumption, that all welding processes were made one after another, i.e. that the control unit is able to cool down during the preparation time of the next fitting: Usage for dimensions from 20 to 630 mm without limitation. When working with dimensions from 630 mm on, longer cool-down times must be provided for because otherwise the device might show the "Device too hot" error message. In this case, it is necessary to let the device cool down before putting it to use again. Before processing fittings in this dimension range, you have to check that the welding current demand of the fitting does not continuously exceed the output current of the device and that the maximum output current is not exceeded. All above made statements refer to an ambient temperature of 20°C.



Technical Data

3_0206_103 Polymatic Plus (USB)

General

Output voltage	8 to 48 DC [V]
Data recording	Yes
Power (60 % ON time) according to ISO 12176-2	2600 W (72.5 A)
Operating temperature range	-10 to +50 [°C]
International protection	IP54
Application class	1
Conformity	CE
ISO 12176-2 Class - classification	P ₂ 4 U S ₁ V AK D X

Input of welding parameters

Barcode with reading pen (with scanner optional)	Yes
SmartFuse/(FUSAMATIC)	Yes
Manual input of fittingcode	Yes
Manual input of welding parameters	Yes, U _{OUT} : 8 to 48 V, t _{WELD} : 0 to 9999 s
Manual input of welding parameters	No, U _{OUT} : 48V (preset), t _{WELD} : 0 to 9999 s

Input/Mains

Type of voltage	AC
Nominal voltage	230 [V]
Nominal voltage range (tolerance)	185 to 300 [V]
Nominal frequency	50 [Hz]
Nominal frequency range (Tolerance)	40 to 70 [Hz]
Power factor cos φ	0.6 to 0.9 (phase-angle control)
Nominal current	16 [A]
Power consumption	3600 [VA]
Length of cord	4.5 [m]
Plug type	Euro plug

Output

Type of voltage	AC
Output voltage	8 to 48 [V]
Output current (max.)	110 [A]
Output current (t → ∞)	40 [A]
Output current (min.)	2 [A]
Energy adjustment	Temperature compensation
Welding cable length	5 [m], other lengths on request
Welding cable mounting	Fixed
Welding terminals	4 [mm]
Optional adapters for terminals	4 to 4.7 [mm]

Monitoring functions

Input	Voltage, Current, Frequency
Output	Voltage, Current, Resistance, Contact, Short circuit
Other	System, Working Temperature, Service
Error messages	Plain Text, Acoustic Signal

Casing

Material	Steel plate with plastic casing
Display	4 × 20 Characters (alphanum.), background lighting
Product weight (excl. welding cable)	16 [kg]
Product weight (incl. welding cable)	18 [kg]
Dimensions L × W × H	450 × 325 × 380 [mm]

Data recording

The electrofusion control unit Polymatic Plus (USB) provides data recording for approx. 1000 welding cycles.

Packaging

Type	Flightcase
Dimensions	500 × 420 × 385 [mm]
Packaging weight	8 [kg]
Transport weight	24 [kg]

Recorded data

General data	Time, date, report number, ambient temperature
Fusion data	Voltage, Current, Energy, Nominal and Actual Welding Time, Mode, Resistance, Error messages with 10 voltage and current values
Fitting data	Barcode Information (ISO/TR 13950), Type, Dimension, Manufacturer
Device data	Serial Number, Inventory Number, Date of last Service, Working Hours, System Configuration
Workercode	Barcode (PF or ISO 12176-3) for operator identification and access to manual input and system configuration

Traceability functions

Job-code	Job number max. 40-digits (alphanumerical), input by barcode or manual
Workercode	ISO-1276-3
Weld Number	DVS 2207 / 2208
Welding Barcode	ISO-TR 13950
Traceability Barcode of Fitting	ISO-12176-4
Traceability Barcode of 1st pipe	ISO-12176-4
Traceability Barcode of 2nd pipe	ISO-12176-4
3rd Traceability Code / Infotext	ISO-12176-4 / 40-digit (alphanumerical)

Duty cycle according to ISO 12176-2 at 30%, 60% and 100%, Test time t = 60 minutes

Test time	Output power at U _{OUT} = 36 V	Output power at U _{OUT} = 40 V	Output current I _{OUT}
60 min			
30%	3500 W	3900 W	97.3 A
60%	2600 W	2900 W	72.5 A
100%	2100 W	2350 W	58.4 A

Tiny Data MF (USB)

3.0208T108

Scope of application

The electrofusion control units of type Tiny MF (USB) are exclusively for the electrofusion of thermoplastic pipes (e.g. made of PE-HD, PE80, PE100 or PP) by use of electrofusion fittings with a welding voltage lower than 48V. The control units conform to the standard DVS 2208-1 as well as to ISO-12176-2 which refer to the standards applicable for the electro fusion fittings to be used.

Range of fitting dimensions

For which range of fitting dimensions an electrofusion control unit can be used depends essentially on the power consumption of the used fittings. Since the power consumption of the fittings is different for different fitting manufacturers, a general statement concerning this point cannot be made. In case of doubt, each single case has to be checked separately. For electro fusion control units of type Tiny MF (USB) the following general statement can be made, with the assumption, that all welding processes were made one after another, i.e. that the control unit is able to cool down during the preparation time of the next fitting: Usage for dimensions from 20 to 355 mm without limitation. When working with dimensions from 400 mm on, longer cool-down times must be provided for because otherwise the device might show the "Device too hot" error message. In this case, it is necessary to let the device cool down before putting it to use again. Before processing fittings in this dimension range, you have to check that the welding current demand of the fitting does not continuously exceed the output current of the device and that the maximum output current is not exceeded. All above made statements refer to an ambient temperature of 20°C.



Technical Data	
3_0208T108	Tiny Data MF (USB)
General	
Output voltage	8 to 48 DC
Data recording	Yes
Power (60 % ON time) according to ISO 12176-2	2050 W (55.9 A)
Operating temperature range	-10 to +50 [°C]
International protection	IP54
Application class	1
Conformity	CE
ISO 12176-2 Class - classification	P ₂ 3 U S ₁ V AK D X
Input of welding parameters	
Barcode with reading pen (with scanner optional)	Yes
SmartFuse/(FUSAMATIC)	Yes
Manual input of fittingcode	Yes
Manual input of welding parameters	Yes, U _{OUT} : 8 to 48 V, t _{WELD} : 0 to 9999 s
Manual input of welding parameters	No, U _{OUT} : 48V (preset), t _{WELD} : 0 to 9999 s
Input/Mains	
Type of voltage	AC
Nominal voltage	230 [V]
Nominal voltage range (tolerance)	185 to 300 [V]
Nominal frequency	50 [Hz]
Nominal frequency range (Tolerance)	40 to 70 [Hz]
Power factor cos ϕ	0.6 to 0.9 (phase-angle control)
Nominal current	16 [A]
Power consumption	3200 [VA]
Length of cord	5 [m]
Plug type	Euro plug
Output	
Type of voltage	AC
Output voltage	8 to 48 [V]
Output current (max.)	110 [A]
Output current (t → ∞)	30 [A]
Output current (min.)	2 [A]
Energy adjustment	Temperature compensation
Welding cable length	4 [m], other lengths on request
Welding cable mounting	Fixed
Welding terminals	4,0 [mm] (optional 4,7 [mm])
Monitoring functions	
Input	Voltage, Current, Frequency
Output	Voltage, Current, Resistance, Contact, Short circuit
Other	System, Working Temperature, Service
Error messages	Plain Text, Acoustic Signal

Casing			
Material	Steel plate		
Display	4 x 20 Characters (alphanum.), background lighting		
Product weight (excl. welding cable)	14 [kg]		
Product weight (incl. welding cable)	16.5 [kg]		
Dimensions L x W x H	325 x 275 x 290 [mm]		
Data recording			
The electrofusion control unit Tiny Data MF (USB) provides data recording for approx. 1000 welding cycles.			
Packaging			
Type	Flightcase		
Dimensions	500 x 420 x 385 [mm]		
Packaging weight	8 [kg]		
Transport weight	24 [kg]		
Recorded data			
General data	Time, date, report number, ambient temperature		
Fusion data	Voltage, Current, Energy, Nominal and Actual Welding Time, Mode, Resistance, Error messages with 10 voltage and current values		
Fitting data	Barcode Information (ISO/TR 13950), Type, Dimension, Manufacturer		
Device data	Serial Number, Inventory Number, Date of last Service, Working Hours, System Configuration		
Workercode	Barcode (PF or ISO 12176-3) for operator identification and access to system configuration		
Traceability functions			
Job-code	Job number max. 40-digits (alphanumeric), input by barcode or manual		
Workercode	ISO-1276-3		
Weld Number	DVS 2207 / 2208		
Welding Barcode	ISO-TR 13950		
Traceability Barcode of Fitting	ISO-12176-4		
Traceability Barcode of 1st pipe	ISO-12176-4		
Traceability Barcode of 2nd pipe	ISO-12176-4		
3rd Traceability Code / Infotext	ISO-12176-4 / 40-digit (alphanumeric)		
Duty cycle according to ISO 12176-2 at 30%, 60% and 100%, Test time t = 60 minutes			
Test time	Output power at U _{OUT} = 36 V	Output power at U _{OUT} = 40 V	Output current I _{OUT}
60 min			
30%	2700 W	3000 W	74.1 A
60%	2050 W	2250 W	55.9 A
100%	1600 W	1800 W	44.7 A

Digimatic Data (USB)

3.0206.001

Scope of application

The electrofusion control units of type Digimatic Data (USB) are solely meant for the welding of thermoplastic pipes (e.g. made of PE-HD, PE80, PE100 or PP) when used with electrofusion fittings that have an input voltage of less than 48V. These devices are conforming to the standards DVS 2208-1 and ISO-12176-2, of which the applicable standards for the electrofusion fittings to be used are derived from.



Range of fitting dimensions

For which range of fitting dimensions an electrofusion control unit can be used depends essentially on the power consumption of the used fittings. Since the power consumption of the fittings is different for different fitting manufacturers, a general statement concerning this point cannot be made. When in doubt, each single case has to be checked separately. For electrofusion control units of type Digimatic Data (USB) the following general statement can be made, with the assumption, that all welding processes were made one after another, i.e. that the control unit is able to cool down during the preparation time of the next fitting: Usage for dimensions from 20 to 355 mm without limitation. When working with dimensions from 400 mm on, longer cool-down times must be provided for because otherwise the device might show the "Device too hot" error message. In this case, it is necessary to let the device cool down before putting it to use again. Before processing fittings in this dimension range, you have to check that the welding current demand of the fitting does not continuously exceed the output current of the device and that the maximum output current is not exceeded. All above made statements refer to an ambient temperature of 20°C.

Technical Data

3_0206_001 Digimatic Data (USB)

General

Output voltage	8 to 48 DC [V]
Data recording	Yes
Power (60 % ON time) according to ISO 12176-2	2050 W (55.9 A)
Operating temperature range	-10 to +50 [°C]
International protection	IP54
Application class	1
Conformity	CE
ISO 12176-2 Class - classification	P ₂ 3 U S ₁ V AK D X

Input of welding parameters

Barcode with reading pen (with scanner optional)	No
SmartFuse/(FUSAMATIC)	Optional
Manual input of fittingcode	No
Manual input of welding parameters	No, U _{OUT} : 8 to 48 V, t _{WELD} : 0 to 9999 s
Manual input of welding parameters	Yes, U _{OUT} : 48V (preset), t _{WELD} : 0 to 9999 s

Input/Mains

Type of voltage	AC
Nominal voltage	230 [V]
Nominal voltage range (tolerance)	185 to 300 [V]
Nominal frequency	50 [Hz]
Nominal frequency range (Tolerance)	40 to 70 [Hz]
Power factor cos φ	0.6 to 0.9 (phase-angle control)
Nominal current	16 [A]
Power consumption	3600 [VA]
Length of cord	4.5 [m]
Plug type	Euro plug

Output

Type of voltage	AC
Output voltage	8 to 48 [V]
Output current (max.)	110 [A]
Output current (t → ∞)	30 [A]
Output current (min.)	2 [A]
Energy adjustment	Temperature compensation (manual)
Welding cable length	5 [m], other lengths on request
Welding cable mounting	Fixed
Welding terminals	4 [mm]
Optional adapters for terminals	4 to 4.7 [mm]

Monitoring functions

Input	Voltage, Current, Frequency
Output	Voltage, Current, Resistance, Contact, Short circuit
Other	System, Working Temperature, Service
Error messages	Plain Text, Acoustic Signal

Casing

Material	Steel plate with plastic casing
Display	4 × 20 Characters (alphanum.), background lighting
Product weight (excl. welding cable)	16 [kg]
Product weight (incl. welding cable)	18 [kg]
Dimensions L × W × H	450 × 325 × 380 [mm]

Data recording

The electrofusion control unit of type Digimatic Data (USB) provides data recording for approx. 250 welding cycles.

Packaging

Type	Flightcase
Dimensions	500 × 420 × 385 [mm]
Packaging weight	8 [kg]
Transport weight	24 [kg]

Recorded data

General data	Time, date, report number, ambient temperature, welder name, job number max. 20-digits (alphanumerical)
Fusion data	Voltage, Current, Energy, Nominal and Actual Welding Time, Mode, Resistance, Error messages with 10 voltage and current values
Device data	Serial Number, Inventory Number, Date of last Service, Working Hours, System Configuration

Duty cycle according to ISO 12176-2 at 30%, 60% and 100%, Test time t = 60 minutes

Test time	Output power at U _{OUT} = 36 V	Output power at U _{OUT} = 40 V	Output current I _{OUT}
60 min			
30%	2700 W	3000 W	74.1 A
60%	2050 W	2250 W	55.9 A
100%	1600 W	1800 W	44.7 A

PolyControl Plus (USB) V2.0 Universal EF Control Unit

3F0218V112

Scope of application

The electrofusion control boxes of type PolyControl Plus (USB) V2.0 are solely meant for the welding of thermoplastic pipes (e.g. made of PE-HD, PE80, PE100 or PP) when used with electrofusion fittings that have an input voltage of less than 48V. These devices are conforming to the standards DVS 2208-1 and ISO-12176-2, of which the applicable standards for the electrofusion fittings to be used are derived from.

Range of fitting dimensions

For which range of fitting dimensions an electrofusion control unit can be used depends essentially on the power consumption of the used fittings. Since the power consumption of the fittings is different for different fitting manufacturers, a general statement concerning this point cannot be made. When in doubt, each single case has to be checked separately. For electrofusion control boxes of type PolyControl Plus (USB) V2.0 the following general statement can be made with the assumption, that all welding processes are made one after another, i.e. that the control unit is able to cool down during the preparation time of the next fitting: Usable for all dimensions with up to 85 A permanent current consumption without limitation. All above made statements refer to an ambient temperature of 20°C.

Note: If the fan on the back side of the controller is not running, the dimension range is reduced to the following sizes: up to 250 mm without limit. 280-400 mm with cool down phases. You should not use the controller without a running fan for dimensions larger than 400 mm to avoid damaging the device.



Technical Data	
3F0218V112	PolyControl Plus (USB) V2.0
General	
Output voltage	8 to 48 DC [V]
Data recording	Yes
Power (60 % ON time) according to ISO 12176-2	3600 W (100 A)
Operating temperature range	-10 to +50 [°C]
International protection	IP54
Application class	1
Conformity	CE
ISO 12176-2 Class - classification	P ₂ 4 U S ₁ V AK D X
Input of welding parameters	
Barcode with reading pen (with scanner optional)	Yes
SmartFuse/(FUSAMATIC)	Yes
Manual input of fittingcode	Yes
Manual input of welding parameters	Yes, U _{OUT} : 8 to 48 V, t _{WELD} : 0 to 9999 s
Manual input of welding parameters	No, U _{OUT} : 48V (preset), t _{WELD} : 0 to 9999 s
Input/Mains	
Type of voltage	AC
Nominal voltage	230 [V]
Nominal voltage range (tolerance)	185 to 300 [V]
Nominal frequency	50 [Hz]
Nominal frequency range (Tolerance)	40 to 70 [Hz]
Power factor cos ϕ	1 - PFC (EN 61000-3-3)
Nominal current	16 [A]
Power consumption	3600 [VA]
Length of cord	4.5 [m]
Plug type	Euro plug
Output	
Type of voltage	DC
Output voltage	8 to 48 [V]
Output current (max.)	110 [A]
Output current (t → ∞)	85 [A]
Output current (min.)	2 [A]
Energy adjustment	Temperature compensation, Inductivity compensation
Welding cable length	3 [m]
Welding cable mounting	Fixed
Welding terminals	4,0 [mm] (optional 4,7 [mm])
Monitoring functions	
Input	Voltage, Current, Frequency
Output	Voltage, Current, Resistance, Contact, Short circuit
Other	System, Working Temperature, Service
Error messages	Plain Text, Acoustic Signal

Casing			
Material	Cast aluminium		
Display	4 x 20 Characters (alphanum.), background lighting		
Product weight (excl. welding cable)	11 [kg]		
Product weight (incl. welding cable)	15.5 [kg]		
Dimensions L x W x H	220 x 317 x 435 [mm]		
Data recording			
The electrofusion control box PolyControl Plus (USB) V2.0 provides data recording for approx. 1000 welding cycles and their traceability data conforming to ISO-12176-4:			
Packaging			
Type	Flightcase		
Dimensions	500 x 420 x 385 [mm]		
Packaging weight	8 [kg]		
Transport weight	24 [kg]		
Recorded data			
Fusion data	Voltage, Current, Energy, Nominal and Actual Welding Time, Mode, Resistance, Error messages with 10 voltage and current values		
Fitting data	Barcode Information (ISO/TR 13950), Type, Dimension, Manufacturer		
Device data	Serial Number, Inventory Number, Date of last Service, Working Hours, System Configuration		
Worker Code	Barcode (PF or ISO 12176-3) for operator identification and access to manual input and system configuration		
Traceability functions			
Commission-Number (Job-Code)	Max. 40-digits (alphanumeric) by Barcode		
Worker Code	ISO-12176-3		
Weld Number	DVS 2207 / 2208		
Welding Barcode	ISO-TR 13950		
Traceability Barcode of Fitting	ISO-12176-4		
Traceability Barcode of 1st pipe	ISO-12176-4		
Traceability Barcode of 2st pipe	ISO-12176-4		
3rd Traceability Code / Infotext	ISO-12176-4 / 40-digit (alphanumeric)		
Duty cycle according to ISO 12176-2 at 30%, 60% and 100%, Test time t = 60 minutes			
Test time	Output power at U _{OUT} = 36 V	Output power at U _{OUT} = 40 V	Output current I _{OUT}
60 min			
30%	3960 W	4400 W	110 A
60%	3600 W	4000 W	100 A
100%	3240 W	3600 W	90 A

ESPAÑOL



El sistema inteligente ElectroFusion de Plasson

Plasson ofrece herramientas y soldadoras automáticas de electrofusión de la más alta calidad, para facilitar la instalación y asegurar conexiones fiables.

Todos los productos de Plasson se combinan para brindar la solución más avanzada y eficiente de conexión de tuberías. Los accesorios de Plasson contienen un sistema de reconocimiento automático que forma parte de todo el sistema inteligente. La soldadora automática ejecuta y supervisa todo el proceso de electrofusión.

Los accesorios ElectroFusion de Plasson pueden utilizarse con la soldadora automática de Plasson, controlada por computadora, o con los sistemas estándar de código de barras.

Cada accesorio ("fitting") ElectroFusion de Plasson se entrega completo, con su propio código de barras.

Plasson se enorgullece de suministrar productos de excelente calidad y un servicio incomparable, respaldado por una experiencia de más de 40 años en el terreno.

Para obtener información sobre toda la línea de herramientas, consulte a su representante local de Plasson.

Soldadoras

La línea de soldadoras automáticas de PLASSON tiene las siguientes características:

- Soldadura automática para los enlaces ("cuplas") ElectroFusion de PLASSON hasta 12 IPS
- Diseño ergonómico
- Sistema de supervisión del proceso de electrofusión
- Soldadura totalmente monitorizada
- Pantalla de 4 x 20 caracteres alfanuméricos con iluminación de fondo y contraste ajustable
- Entrada de datos fácil y cómoda para el usuario
- Cable de soldadura altamente flexible
- Ahorro en costos de servicio gracias a la calibración controlada por software
- Facilidad en la transferencia de datos a PC, impresora o dispositivo de memoria portátil

Monomatic Data (USB) Soldadora automática SmartFuse

3.0206.000

Rango de aplicación

Las soldadoras de electrofusión del tipo Monomatic Data (USB) están exclusivamente destinadas a la soldadura de tubos termoplásticos (o sea de PE-HD, PE80, PE100 o PP) con accesorios de menos de 48V en su voltaje de entrada. Estos dispositivos cumplen las especificaciones de las normativas DVS 2208-1 e ISO-12176-2, de las cuales derivan las normas aplicables a los equipos de electrofusión.

Rango de dimensiones

El rango de dimensiones de los accesorios para los cuales puede utilizarse una soldadora depende en primer lugar del consumo de energía de los accesorios. Dado que el consumo no es uniforme para todos los fabricantes, no es posible generalizar, y en caso de duda, es preciso examinar cada accesorio por separado. Para las soldadoras del tipo Monomatic Data (USB), y suponiendo que todas las operaciones de soldadura se realizan en secuencia, es decir que la soldadora tiene tiempo para enfriarse mientras se prepara el accesorio siguiente, se podría emitir la siguiente declaración general: Sin limitaciones para el uso con accesorios de 20 a 355 mm. Al trabajar con dimensiones a partir de los 400 mm se requieren periodos más prolongados de enfriamiento, porque de otro modo podría aparecer el mensaje de error "Device too hot" (Dispositivo recalentado). En tal caso será preciso dejar que el equipo se enfríe antes de volver a utilizarlo. Antes de procesar accesorios dentro de este rango de dimensiones es necesario comprobar que la demanda de corriente del accesorio no sobrepase constantemente la corriente de salida del dispositivo, y tener cuidado de no sobrepasar la corriente máxima de salida. Todo lo dicho se refiere al trabajo con una temperatura ambiente de 20°C.



Especificaciones técnicas

3_0206_000 Monomatic Data (USB)

General

Tensión de salida	40 AC [V]
Registro de datos	Sí
Potencia (60% del tiempo ON)	2050 W (55.9 A)
conformidad con ISO 12176-2	
Rango de temperaturas	-10 a +50 [°C]
Protección	IP54
Clase de aplicación	1
Conformidad con	CE
Clase ISO 12176-2 - clasificación	P ₂ 3 U S ₁ F A D M

Entrada de parámetros de soldadura

Código de barras con lector (escaneo opcional)	No
SmartFuse/(FUSAMATIC)	Sí
Entrada manual del código del accesorio	No
Entrada manual de parámetros de soldadura	No, U _{OUT} : 8 a 48 V, t _{WELD} : 0 a 9999 s
Entrada manual de parámetros de soldadura	No, U _{OUT} : 48V (prefijado), t _{WELD} : 0 a 9999 s

Entrada/Red eléctrica

Tensión	AC
Tensión nominal	230 [V]
Rango de tensión nominal (tolerancia)	185 a 300 [V]
Frecuencia nominal	50 [Hz]
Rango de frecuencia nominal (Tolerancia)	40 a 70 [Hz]
Factor de potencia cos ϕ	0.6 a 0.9 (control de desfase)
Corriente nominal	16 [A]
Consumo eléctrico	3600 [VA]
Longitud del cable	4.5 [m]
Tipo de enchufe	Euro plug

Salida

Tensión	AC
Tensión de salida	40 [V]
Corriente de salida (max.)	110 [A]
Corriente de salida (t $\rightarrow \infty$)	30 [A]
Corriente de salida (min.)	2 [A]
Ajuste de energía	Ninguno
Longitud del cable de soldadura	5 [m], otras longitudes a pedido
Montaje del cable de soldadura	Fijo
Terminales de soldadura	4.0 [mm] (opcional 4.7 [mm])

Funciones de monitorización

Tensión de entrada	Corriente, Frecuencia
Tensión de salida	Corriente, Resistencia, Contacto, Cortocircuito
Otro	Otro sistema, Temperatura de trabajo, Servicio
Mensajes de error	Texto, Señal acústica

Caja

Material	Placa de acero con recubrimiento plástico
Pantalla	4 x 20 caracteres (alfanuméricos), iluminación de fondo
Peso del producto (sin cable de soldadura)	16 [kg]
Peso del producto (cable de soldadura incluido)	18 [kg]
Dimensiones Long x An x Alt	450 x 325 x 380 [mm]

Registro de datos

La soldadora Monomatic Data (USB) proporciona el registro de datos de soldadura para 250 ciclos.

Embalaje

Tipo	Flightcase
Dimensiones	500 x 420 x 385 [mm]
Peso del embalaje	8 [kg]
Peso para el transporte	24 [kg]

Datos registrados

Datos generales	Hora, fecha, número de informe, temperatura ambiente
Datos de fusión	Tensión, corriente, consumo, duración del proceso (nominal y real), Hora, modo, resistencia, mensajes de error con 10 valores de tensión y corriente
Datos del dispositivo	Nº de serie, Nº de inventario, Fecha del último servicio, Horas de trabajo, Configuración del sistema

Ciclo de servicio conformidad con ISO 12176-2 a 30%, 60% y 100%, duración test t = 60 minutos

Duración test 60 min	Potencia de salida a U _{OUT} = 36 V	Potencia de salida a U _{OUT} = 40 V	Corriente de salida I _{OUT}
30%	2700 W	3000 W	74.1 A
60%	2050 W	2250 W	55.9 A
100%	1600 W	1800 W	44.7 A

Polymatic Plus (USB)

3.0206.103

Rango de aplicación

Las soldadoras de electrofusión del tipo Polymatic Plus (USB) están exclusivamente destinadas a la soldadura de tubos termoplásticos (o sea de PE-HD, PE80, PE100 o PP) con accesorios de menos de 48V en su voltaje de entrada. Estos dispositivos cumplen las especificaciones de las normativas DVS 2208-1 e ISO-12176-2, de las cuales derivan las normas aplicables a los equipos de electrofusión.

Rango de dimensiones

El rango de dimensiones de los accesorios para los cuales puede utilizarse una soldadora depende en primer lugar del consumo de energía de los accesorios. Dado que el consumo no es uniforme para todos los fabricantes, no es posible generalizar, y en caso de duda, es preciso examinar cada accesorio por separado. Para las soldadoras del tipo Polymatic Plus (USB), y suponiendo que todas las operaciones de soldadura se realizan en secuencia, es decir que la soldadora tiene tiempo para enfriarse mientras se prepara el accesorio siguiente, se podría emitir la siguiente declaración general: Sin limitaciones para el uso con accesorios de 20 a 630 mm. Al trabajar con dimensiones a partir de los 630 mm se requieren periodos más prolongados de enfriamiento, porque de otro modo podría aparecer el mensaje de error "Device too hot" (Dispositivo recalentado). En tal caso será preciso dejar que el equipo se enfríe antes de volver a utilizarlo. Antes de procesar accesorios dentro de este rango de dimensiones es necesario comprobar que la demanda de corriente del accesorio no sobrepase constantemente la corriente de salida del dispositivo, y tener cuidado de no sobrepasar la corriente máxima de salida. Todo lo dicho se refiere al trabajo con una temperatura ambiente de 20°C



Especificaciones técnicas	
3_0206_103	Polymatic Plus (USB)
General	
Tensión de salida	8 a 48 DC [V]
Registro de datos	Sí
Potencia (60% del tiempo ON)	2600 W (72.5 A)
conformidad con ISO 12176-2	
Rango de temperaturas	-10 a +50 [°C]
Protección	IP54
Clase de aplicación	1
Conformidad con	CE
Clase ISO 12176-2 - clasificación	P ₂ 4 U S ₁ V AK D X
Entrada de parámetros de soldadura	
Código de barras con lector (escaneo opcional)	Sí
SmartFuse/(FUSAMATIC)	Sí
Entrada manual del código del accesorio	Sí
Entrada manual de parámetros de soldadura	Sí, U _{OUT} : 8 a 48 V, t _{WELD} : 0 a 9999 s
Entrada manual de parámetros de soldadura	No, U _{OUT} : 48V (prefijado), t _{WELD} : 0 a 9999 s
Entrada/Red eléctrica	
Tensión	AC
Tensión nominal	230 [V]
Rango de tensión nominal (tolerancia)	185 a 300 [V]
Frecuencia nominal	50 [Hz]
Rango de frecuencia nominal (Tolerancia)	40 a 70 [Hz]
Factor de potencia cos φ	0.6 a 0.9 (control de desfase)
Corriente nominal	16 [A]
Consumo eléctrico	3600 [VA]
Longitud del cable	4.5 [m]
Tipo de enchufe	Euro plug
Salida	
Tensión	AC
Tensión de salida	8 a 48 [V]
Corriente de salida (max.)	110 [A]
Corriente de salida (t → ∞)	40 [A]
Corriente de salida (min.)	2 [A]
Ajuste de energía	Compensación de temperatura
Longitud del cable de soldadura	5 [m], otras longitudes a pedido
Montaje del cable de soldadura	Fijo
Terminales de soldadura	4 [mm]
Adaptadores opcionales para terminales	4 to 4.7 [mm]
Funciones de monitorización	
Tensión de entrada	Corriente, Frecuencia
Tensión de salida	Corriente, Resistencia, Contacto, Cortocircuito
Otro	Sistema, Temperatura de trabajo, Servicio
Mensajes de error	Texto, Señal acústica

Caja			
Material	Placa de acero con recubrimiento plástico		
Pantalla	4 x 20 caracteres (alfanuméricos), iluminación de fondo		
Peso del producto (sin cable de soldadura)	16 [kg]		
Peso del producto (cable de soldadura incluido)	18 [kg]		
Dimensiones Long x An x Alt	450 x 325 x 380 [mm]		
Registro de datos			
La soldadora Polymatic Plus (USB) proporciona el registro de datos de soldadura para 1000 ciclos.			
Embalaje			
Tipo	Flightcase		
Dimensiones	500 x 420 x 385 [mm]		
Peso del embalaje	8 [kg]		
Peso para el transporte	24 [kg]		
Datos registrados			
Datos generales	Hora, fecha, número de informe, temperatura ambiente		
Datos de fusión	Tensión, corriente, consumo, duración del proceso (nominal y real), Hora, modo, resistencia, mensajes de error con 10 valores de tensión y corriente		
Datos accesorio	Código de barras (ISO/TR 13950), Tipo, Dimensión, Fabricante		
Datos del dispositivo	Nº de serie, Nº de inventario, Fecha del último servicio, Horas de trabajo, Configuración del sistema		
Código operador	(PF o ISO 12176-3) identificación personal y acceso a entrada manual y configuración del sistema		
Funciones de rastreo			
Código	encargo y Nº (máximo 40 caracteres) ingreso por código de barras o manual		
Código operador	ISO-1276-3		
Número Sold.	DVS 2207 / 2208		
Código soldadura	ISO-TR 13950		
Rastreo código accesorio	ISO-12176-4		
Rastreo código tubo 1	ISO-12176-4		
Rastreo código tubo 2	ISO-12176-4		
Rastreo código 3 / Infotext	ISO-12176-4 / 40 caracteres		
Ciclo de servicio conformidad con ISO 12176-2 a 30%, 60% y 100%, Duración test t = 60 minutos			
Duración test	Potencia de salida	Potencia de salida	Corriente de salida
60 min	a U _{OUT} = 36 V	a U _{OUT} = 40 V	I _{OUT}
30%	3500 W	3900 W	97.3 A
60%	2600 W	2900 W	72.5 A
100%	2100 W	2350 W	58.4 A

Tiny Data MF (USB)

3.0208T108

Rango de aplicación

Las soldadoras de electrofusión del tipo Tiny MF (USB) están exclusivamente destinadas a la soldadura de tubos termoplásticos (o sea de PE-HD, PE80, PE100 o PP) con accesorios de menos de 48V en su voltaje de entrada. Estos dispositivos cumplen las especificaciones de las normativas DVS 2208-1 e ISO-12176-2, de las cuales derivan las normas aplicables a los equipos de electrofusión.

Rango de dimensiones

El rango de dimensiones de los accesorios para los cuales puede utilizarse una soldadora depende en primer lugar del consumo de energía de los accesorios. Dado que el consumo no es uniforme para todos los fabricantes, no es posible generalizar, y en caso de duda, es preciso examinar cada accesorio por separado. Para las soldadoras del tipo Tiny MF (USB), y suponiendo que todas las operaciones de soldadura se realizan en secuencia, es decir que la soldadora tiene tiempo para enfriarse mientras se prepara el accesorio siguiente, se podría emitir la siguiente declaración general: Sin limitaciones para el uso con accesorios de 20 a 355 mm. Al trabajar con dimensiones a partir de los 400 mm se requieren periodos más prolongados de enfriamiento, porque de otro modo podría aparecer el mensaje de error "Device too hot" (Dispositivo recalentado). En tal caso será preciso dejar que el equipo se enfríe antes de volver a utilizarlo. Antes de procesar accesorios dentro de este rango de dimensiones es necesario comprobar que la demanda de corriente del accesorio no sobrepase constantemente la corriente de salida del dispositivo, y tener cuidado de no sobrepasar la corriente máxima de salida. Todo lo dicho se refiere al trabajo con una temperatura ambiente de 20°C.



Especificaciones técnicas

3_0208T108 Tiny Data MF (USB)

General

Tensión de salida	8 a 48 DC
Registro de datos	Sí
Potencia (60% del tiempo ON)	2050 W (55.9 A)
conformidad con ISO 12176-2	
Rango de temperaturas	-10 a +50 [°C]
Protección	IP54
Clase de aplicación	1
Conformidad con	CE
Clase ISO 12176-2 - clasificación	P ₂ 3 U S ₁ V AK D X

Entrada de parámetros de soldadura

Código de barras con lector (escaneo opcional)	Sí
SmartFuse/(FUSAMATIC)	Sí
Entrada manual del código del accesorio	Sí
Entrada manual de parámetros de soldadura	Sí, U _{OUT} : 8 a 48 V, t _{WELD} : 0 a 9999 s
Entrada manual de parámetros de soldadura	No, U _{OUT} : 48V (prefijado), t _{WELD} : 0 a 9999 s

Entrada/Red eléctrica

Tensión	AC
Tensión nominal	230 [V]
Rango de tensión nominal (tolerancia)	185 a 300 [V]
Frecuencia nominal	50 [Hz]
Rango de frecuencia nominal (Tolerancia)	40 a 70 [Hz]
Factor de potencia cos ϕ	0.6 a 0.9 (control de desfase)
Corriente nominal	16 [A]
Consumo eléctrico	3200 [VA]
Longitud del cable	5 [m]
Tipo de enchufe	Euro plug

Salida

Tensión	AC
Tensión de salida	8 a 48 [V]
Corriente de salida (max.)	110 [A]
Corriente de salida (t $\rightarrow \infty$)	30 [A]
Corriente de salida (min.)	2 [A]
Ajuste de energía	Compensación de temperatura
Longitud del cable de soldadura	4 [m], otras longitudes a pedido
Montaje del cable de soldadura	Fijo
Terminales de soldadura	4.0 [mm] (opcional 4.7 [mm])

Funciones de monitorización

Tensión de entrada	Corriente, Frecuencia
Tensión de salida	Corriente, Resistencia, Contacto, Cortocircuito
Otro	Sistema, Temperatura de trabajo, Servicio
Mensajes de error	Texto, Señal acústica

Caja

Material	Placa de acero
Pantalla	4 x 20 caracteres (alfanuméricos), iluminación de fondo
Peso del producto (sin cable de soldadura)	14 [kg]
Peso del producto (cable de soldadura incluido)	16.5 [kg]
Dimensiones Long x An x Alt	325 x 275 x 290 [mm]

Registro de datos

La soldadora Tiny Data MF (USB) proporciona el registro de datos de soldadura para unos 1000 ciclos.

Embalaje

Tipo	Flightcase
Dimensiones	500 x 420 x 385 [mm]
Peso del embalaje	8 [kg]
Peso para el transporte	24 [kg]

Datos registrados

Datos generales	Hora, fecha, número de informe, temperatura ambiente
Datos de fusión	Tensión, corriente, consumo, duración del proceso (nominal y real), Hora, modo, resistencia, mensajes de error con 10 valores de tensión y corriente
Datos accesorio	Código de barras (ISO/TR 13950), Tipo, Dimensión, Fabricante
Datos del dispositivo	Nº de serie, Nº de inventario, Fecha del último servicio, Horas de trabajo, Configuración del sistema
Código operador	(PF o ISO 12176-3) identificación personal y acceso a la configuración del sistema

Funciones de rastreo

Código	encargo y Nº (máximo 40 caracteres) ingreso por código de barras o manual
Código operador	ISO-1276-3
Número Sold.	DVS 2207 / 2208
Código soldadura	ISO-TR 13950
Rastreo código accesorio	ISO-12176-4
Rastreo código tubo 1	ISO-12176-4
Rastreo código tubo 2	ISO-12176-4
Rastreo código 3 / Infotext	ISO-12176-4 / 40 caracteres

Ciclo de servicio conformidad con ISO 12176-2 a 30%, 60% y 100%, Duración test t = 60 minutos

Duración test	Potencia de salida a U _{OUT} = 36 V	Potencia de salida a U _{OUT} = 40 V	Corriente de salida I _{OUT}
60 min			
30%	2700 W	3000 W	74.1 A
60%	2050 W	2250 W	55.9 A
100%	1600 W	1800 W	44.7 A

Digimatic Data (USB)

3.0206.001

Rango de aplicación

Las soldadoras de electrofusión del tipo Digimatic Data (USB) están exclusivamente destinadas a la soldadura de tubos termoplásticos (o sea de PE-HD, PE80, PE100 o PP) con accesorios de menos de 48V en su voltaje de entrada. Estos dispositivos cumplen las especificaciones de las normativas DVS 2208-1 e ISO-12176-2, de las cuales derivan las normas aplicables a los equipos de electrofusión.

Rango de dimensiones

El rango de dimensiones de los accesorios para los cuales puede utilizarse una soldadora depende en primer lugar del consumo de energía de los accesorios. Dado que el consumo no es uniforme para todos los fabricantes, no es posible generalizar, y en caso de duda, es preciso examinar cada accesorio por separado. Para las soldadoras del tipo Digimatic Data (USB), y suponiendo que todas las operaciones de soldadura se realizan en secuencia, es decir que la soldadora tiene tiempo para enfriarse mientras se prepara el accesorio siguiente, se podría emitir la siguiente declaración general: Sin limitaciones para el uso con accesorios de 20 a 355 mm. Al trabajar con dimensiones a partir de los 400 mm se requieren periodos más prolongados de enfriamiento, porque de otro modo podría aparecer el mensaje de error "Device too hot" (Dispositivo recalentado). En tal caso será preciso dejar que el equipo se enfríe antes de volver a utilizarlo. Antes de procesar accesorios dentro de este rango de dimensiones es necesario comprobar que la demanda de corriente del accesorio no sobrepase constantemente la corriente de salida del dispositivo, y tener cuidado de no sobrepasar la corriente máxima de salida. Todo lo dicho se refiere al trabajo con una temperatura ambiente de 20°C.



Especificaciones técnicas

3_0206_001 Digimatic Data (USB)

General

Tensión de salida	8 a 48 DC [V]
Registro de datos	Sí
Potencia (60% del tiempo ON)	2050 W (55.9 A)
conformidad con ISO 12176-2	
Rango de temperaturas	-10 a +50 [°C]
Protección	IP54
Clase de aplicación	1
Conformidad con	CE

Clase ISO 12176-2 - clasificación P₂ 3 U S₁ V AK D X

Entrada de parámetros de soldadura

Código de barras con lector (escaneo opcional)	No
SmartFuse/(FUSAMATIC)	Opcional
Entrada manual del código del accesorio	No
Entrada manual de parámetros de soldadura	No, U _{OUT} : 8 a 48 V, t _{WELD} : 0 a 9999 s
Entrada manual de parámetros de soldadura	Sí, U _{OUT} : 48V (prefijado), t _{WELD} : 0 a 9999 s

Entrada/Red eléctrica

Tensión	AC
Tensión nominal	230 [V]
Rango de tensión nominal (tolerancia)	185 a 300 [V]
Frecuencia nominal	50 [Hz]
Rango de frecuencia nominal (Tolerancia)	40 a 70 [Hz]
Factor de potencia cos φ	0.6 a 0.9 (control de desfase)
Consumo eléctrico	16 [A]
Power consumption	3600 [VA]
Longitud del cable	4.5 [m]
Tipo de enchufe	Euro plug

Salida

Tensión	AC
Tensión de salida	8 a 48 [V]
Corriente de salida (max.)	110 [A]
Corriente de salida (t → ∞)	30 [A]
Corriente de salida (min.)	2 [A]
Ajuste de energía	Compensación de temperatura
Longitud del cable de soldadura	5 [m], otras longitudes a pedido
Montaje del cable de soldadura	Fijo
Terminales de soldadura	4 [mm]
Adaptadores opcionales para terminales	4 to 4.7 [mm]

Funciones de monitorización

Tensión de entrada	Corriente, Frecuencia
Tensión de salida	Corriente, Resistencia Contacto, Cortocircuito
Otro	Sistema, Temperatura de trabajo, Servicio
Mensajes de error	Texto, Señal acústica

Caja

Material	Placa de acero con recubrimiento plástico
Pantalla	4 x 20 caracteres (alfanuméricos), iluminación de fondo
Peso del producto (sin cable de soldadura)	16 [kg]
Peso del producto (cable de soldadura incluido)	18 [kg]
Dimensiones Long x An x Alt	450 x 325 x 380 [mm]

Registro de datos

La soldadora del tipo Digimatic Data (USB) proporciona el registro de datos de soldadura para unos 250 ciclos.

Embalaje

Tipo	Flightcase
Dimensiones	500 x 420 x 385 [mm]
Peso del embalaje	8 [kg]
Peso para el transporte	24 [kg]

Datos registrados

Datos generales	Hora, fecha, número de informe, temperatura ambiente, nombre del soldador, N° encargo max. 20 caracteres (alfanuméricos)
Datos de fusión	Tensión, corriente, consumo, duración del proceso (nominal y real) Hora, modo, resistencia, mensajes de error con 10 valores de tensión y corriente
Datos del dispositivo	N° de serie, N° de inventario, Fecha del último servicio, Horas de trabajo, Configuración del sistema

Ciclo de servicio conformidad con ISO 12176-2 a 30%, 60% y 100%, Duración test t = 60 minutos

Duración test	Potencia de salida a U _{OUT} = 36 V	Potencia de salida a U _{OUT} = 40 V	Corriente de salida I _{OUT}
60 min			
30%	2700 W	3000 W	74.1 A
60%	2050 W	2250 W	55.9 A
100%	1600 W	1800 W	44.7 A

PolyControl Plus (USB) V2.0 Soldadora universal

3F0218V112

Rango de aplicación

Las soldadoras de electrofusión del tipo PolyControl Plus (USB) V2.0 están exclusivamente destinadas a la soldadura de tubos termoplásticos (o sea de PE-HD, PE80, PE100 o PP) con accesorios de menos de 48V en su voltaje de entrada.

Estos dispositivos cumplen las especificaciones de las normativas DVS 2208-1 e ISO-12176-2, de las cuales derivan las normas aplicables a los equipos de electrofusión.

Rango de dimensiones

El rango de dimensiones de los accesorios para los cuales puede utilizarse una soldadora depende en primer lugar del consumo de energía de los accesorios. Dado que el consumo no es uniforme para todos los fabricantes, no es posible generalizar, y en caso de duda, es preciso examinar cada accesorio por separado. Para las soldadoras del tipo PolyControl Plus (USB) V2.0, y suponiendo que todas las operaciones de soldadura se realizan en secuencia, es decir que la soldadora tiene tiempo para enfriarse mientras se prepara el accesorio siguiente, se podría emitir la siguiente declaración general:

Utilizable sin limitaciones para todas las dimensiones de accesorios con hasta 85 A de consumo permanente de corriente. Todo lo dicho se refiere al trabajo con una temperatura ambiente de 20°C.

Nota: Si el ventilador de la parte trasera de la soldadora no está funcionando, el rango de tamaños se reduce a lo siguiente: hasta 250 mm sin limitaciones, de 280 a 400 mm con periodos de enfriamiento. No debe utilizarse la soldadora sin el ventilador para tamaños de más de 400 mm a fin de evitar que el dispositivo resulte dañado.



Especificaciones técnicas

3F0218V112 PolyControl Plus (USB) V2.0

General

Tensión de salida	8 a 48 DC [V]
Registro de datos	Sí
Potencia (60% del tiempo ON)	3600 W (100 A)
conformidad con ISO 12176-2	
Rango de temperaturas	-10 a +50 [°C]
Protección	IP54
Clase de aplicación	1
Conformidad con	CE
Clase ISO 12176-2 - clasificación	P ₂ 4 U S ₁ V AK D X

Entrada de parámetros de soldadura

Código de barras con lector (escaneo opcional)	Sí
SmartFuse/(FUSAMATIC)	Sí
Entrada manual del código del accesorio	Sí
Entrada manual de parámetros de soldadura	Sí, U _{OUT} : 8 a 48 V, t _{WELD} : 0 a 9999 s
Entrada manual de parámetros de soldadura	No, U _{OUT} : 48V (prefijado), t _{WELD} : 0 a 9999 s

Entrada/Red eléctrica

Tensión	AC
Tensión nominal	230 [V]
Rango de tensión nominal (tolerancia)	185 a 300 [V]
Frecuencia nominal	50 [Hz]
Rango de frecuencia nominal (Tolerancia)	40 a 70 [Hz]
Factor de potencia cos ϕ	1 - PFC (EN 61000-3-3)
Corriente nominal	16 [A]
Consumo eléctrico	3600 [VA]
Longitud del cable	4.5 [m]
Tipo de enchufe	Euro plug

Salida

Tensión	DC
Tensión de salida	8 a 48 [V]
Corriente de salida (max.)	110 [A]
Corriente de salida (t $\rightarrow \infty$)	85 [A]
Corriente de salida (min.)	2 [A]
Ajuste de energía	Compensación de temperatura, Compensación de inductividad
Longitud del cable de soldadura	3 [m]
Montaje del cable de soldadura	Fijo
Terminales de soldadura	4.0 [mm] (opcional 4.7 [mm])

Funciones de monitorización

Tensión de entrada	Corriente, Frecuencia
Tensión de salida	Corriente, Resistencia, Contacto, Cortocircuito
Otro	Sistema, Temperatura de trabajo, Servicio
Mensajes de error	Texto, Señal acústica

Caja

Material	Aluminio de fundición
Pantalla	4 x 20 caracteres (alfanuméricos), iluminación de fondo
Peso del producto (sin cable de soldadura)	11 [kg]
Peso del producto (cable de soldadura incluido)	15.5 [kg]
Dimensiones Long x An x Alt	220 x 317 x 435 [mm]

Registro de datos

La soldadora PolyControl Plus (USB) V2.0 proporciona el registro de datos de soldadura para unos 1000 ciclos y datos de rastreo de conformidad con la norma ISO-12176-4:

Embalaje

Tipo	Flightcase
Dimensiones	500 x 420 x 385 [mm]
Peso del embalaje	8 [kg]
Peso para el transporte	24 [kg]

Datos registrados

Datos de fusión	Tensión, corriente, consumo, duración del proceso (nominal y real) Hora, modo, resistencia, mensajes de error con 10 valores de tensión y corriente
Datos accesorio	Código de barras (ISO/TR 13950), Tipo, Dimensión, Fabricante
Datos del dispositivo	Nº de serie, Nº de inventario, Fecha del último servicio, Horas de trabajo, Configuración del sistema
Código de barras (PF o ISO 12176-3) identificación personal y acceso a del operador	entrada manual y configuración del sistema

Funciones de rastreo

Nº encargo (código del trabajo)	Max. 40 caracteres (alfanuméricos) por código de barras
Código operador	ISO-12176-3
Número Sold.	DVS 2207 / 2208
Código soldadura	ISO-TR 13950
Rastreo código accesorio	ISO-12176-4
Rastreo código tubo 1	ISO-12176-4
Rastreo código tubo 2	ISO-12176-4
Rastreo código 3 / Infotext	ISO-12176-4 / 40 caracteres

Ciclo de servicio conformidad con ISO 12176-2 a 30%, 60% y 100%, Duración test t = 60 minutos

Duración test	Potencia de salida a U _{OUT} = 36 V	Potencia de salida a U _{OUT} = 40 V	Corriente de salida I _{OUT}
60 min			
30%	3960 W	4400 W	110 A
60%	3600 W	4000 W	100 A
100%	3240 W	3600 W	90 A

Extension Key for Tapping Valve

Liave de Extensión para Toma de Servicio Con Válvula

49546010	0.8 - 1.1mm
49546020	1.0 - 1.4mm
49546030	1.2 - 1.8mm



Key for Tapping Saddle

Liave para Toma de Servicio

29202000	18cm
-----------------	------



Hand Scrappers

Raspatubos Manual

29145.3002.001	1.1/2"
29145.3002.003	2.1/2"



Rotational Scraper Tools

Raspatubos Giratorios

29144.4200.001	25-63mm
29144.4200.002	25-110mm
29144.4200.003	90-225mm
29144.4200.014	90-315mm
29175160	50-160mm
29170315	75-315mm
29170710	355-710mm



29144.4200.009	250-800mm
-----------------------	-----------



Plasson Scraper Tool for Pipe Ends

Raspatubos Giratorio Plasson

2912020063	20-63mm
29144.4200.015	75-180mm
29144.4200.016	180-400mm
2912450800	450-800mm



Pipe Cutter

Cortadores de Tubería

29145.3000.005	42mm
29145.3000.007	63mm, One-Hand Operation
29145.3000.001	63mm



Rotational Pipe Cutter (S-Type)

Cortador de Tubería Giratorio (Tipo S)

29145.3001.004	20-75mm
29145.3001.001	50-140mm
29145.3001.002	90-160mm



Rotational Pipe Cutters

Cortador de Tubería Giratorio

29144.4400.002	32-110mm
29144.4400.001	110-225mm



Pipe Clamping Tools

Herramientas de Sujeción de Tubos

29144.4300.006	20-63mm
29144.4300.001	32-110mm
29144.4300.002	110-225mm
29144.4300.021	250-630mm
29144.4300.016	63-200mm
29363180	63-180mm
29363110	63-110mm



Squeeze - Off Tools

Prensatubos

- 29144.4100.001** 20-63mm SDR11
- 29144.4100.002** 63mm SDR11
- 29144.4100.003** 75-200mm



Rounding Rings

Redondeadores

- 29600040** 40mm
- 29600050** 50mm

- 29145.3006.063** 65mm
- 29145.3006.075** 75mm
- 29145.3006.090** 90mm
- 29145.3006.110** 110mm
- 29145.3006.125** 125mm
- 29145.3006.160** 160mm
- 29145.3006.180** 180mm
- 29145.3006.200** 200mm
- 29145.3006.225** 225mm
- 29600250** 250mm



Detergents

Detergentes

- 29145.2000.001** Tangit Detergent, 1 Liter
- 29145.2000.002** 100 Cleaning Pads with Tangit



Markers

Marcadores

- 29145.3100.018** Plasson Marking Pen, White, 10 pcs
- 29145.3100.019** Plasson Marking Pen, silver, 10 pcs
- 2960003** Plasson Marking Pen, silver, 10 pcs



Rounding Tool

Redondeador hidráulico

- 29144.4702.000** Rounding Tool 450-800 Hydraulic
Redondeador hidráulico 450-800



Tools for Branch Saddle & Transition Saddle sizes: 250-800 (See pages 19,20)

Herramientas para collarines de derivación y transición. Tamaños: 250-800 (ver páginas 19 y 20)

- 29144.4702.000** Core Drill Kit for Plasson-Saddle Outlet 90mm/110mm/125mm/160mm
Juego de punzones para collarines de Plasson 90mm/110mm/125mm/160mm



- 29144.4701.001** Large Bore Saddle Clamp 250-800mm – Complete Kit
Presilla de sujeción para collarines 250-800 mm - Juego completo



Tools for Wastewater Saddles (See Pages 34-35)

Herramientas para enlaces para aguas residuales (ver páginas 34-35)

- 29144.4700.001** Drilling And Clamping Tools (set) for Wastewater Branch Saddle 160 mm
Juego de herramientas de perforación y sujeción para collarines de derivación para aguas residuales 160 mm



- 29070050** Cutting and Clamping Tools for 45° Wastewater Saddle 110Mm
Herramientas de corte y sujeción para collarines de 45° para aguas residuales 110 mm

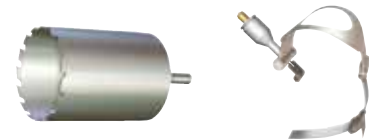

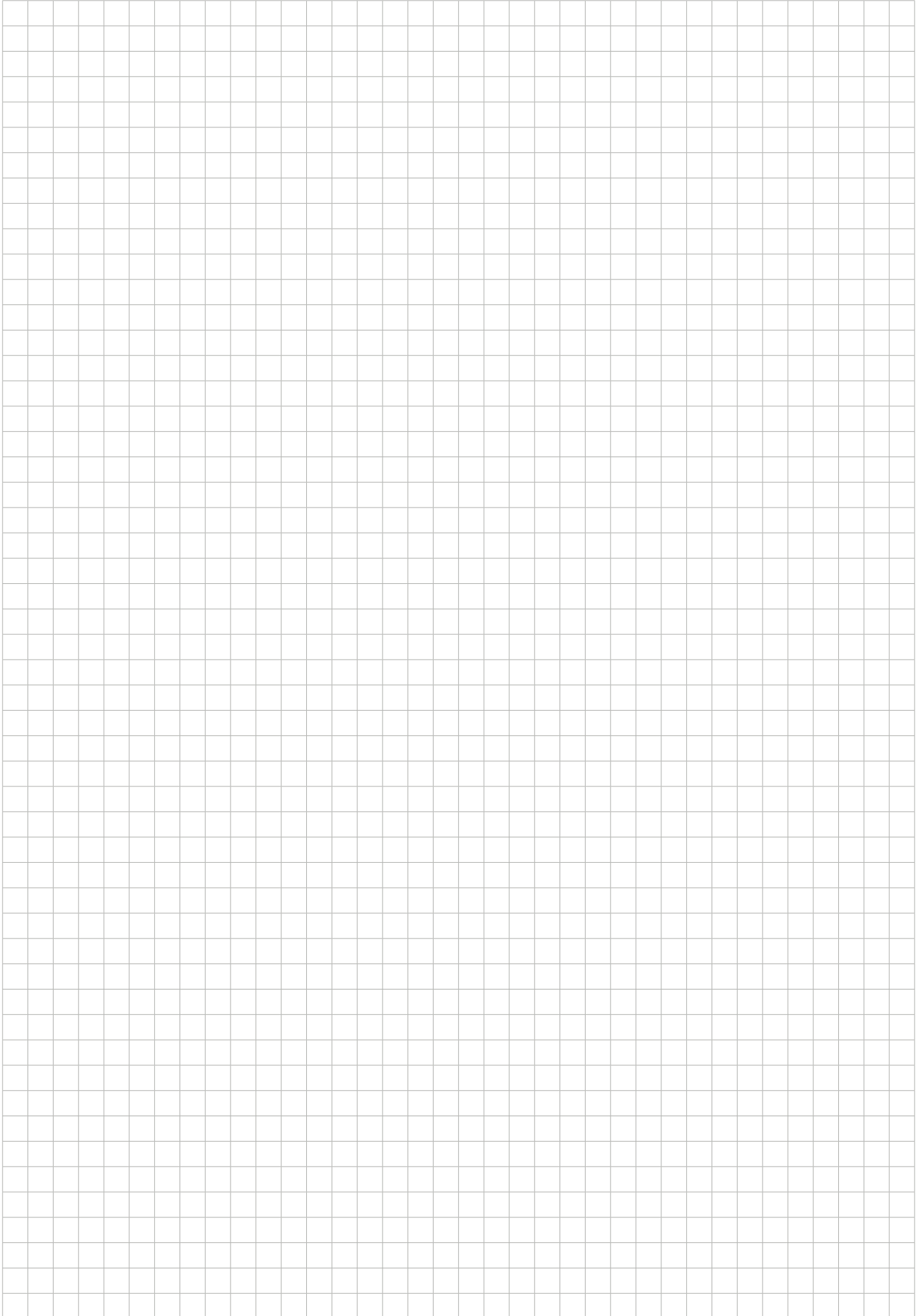

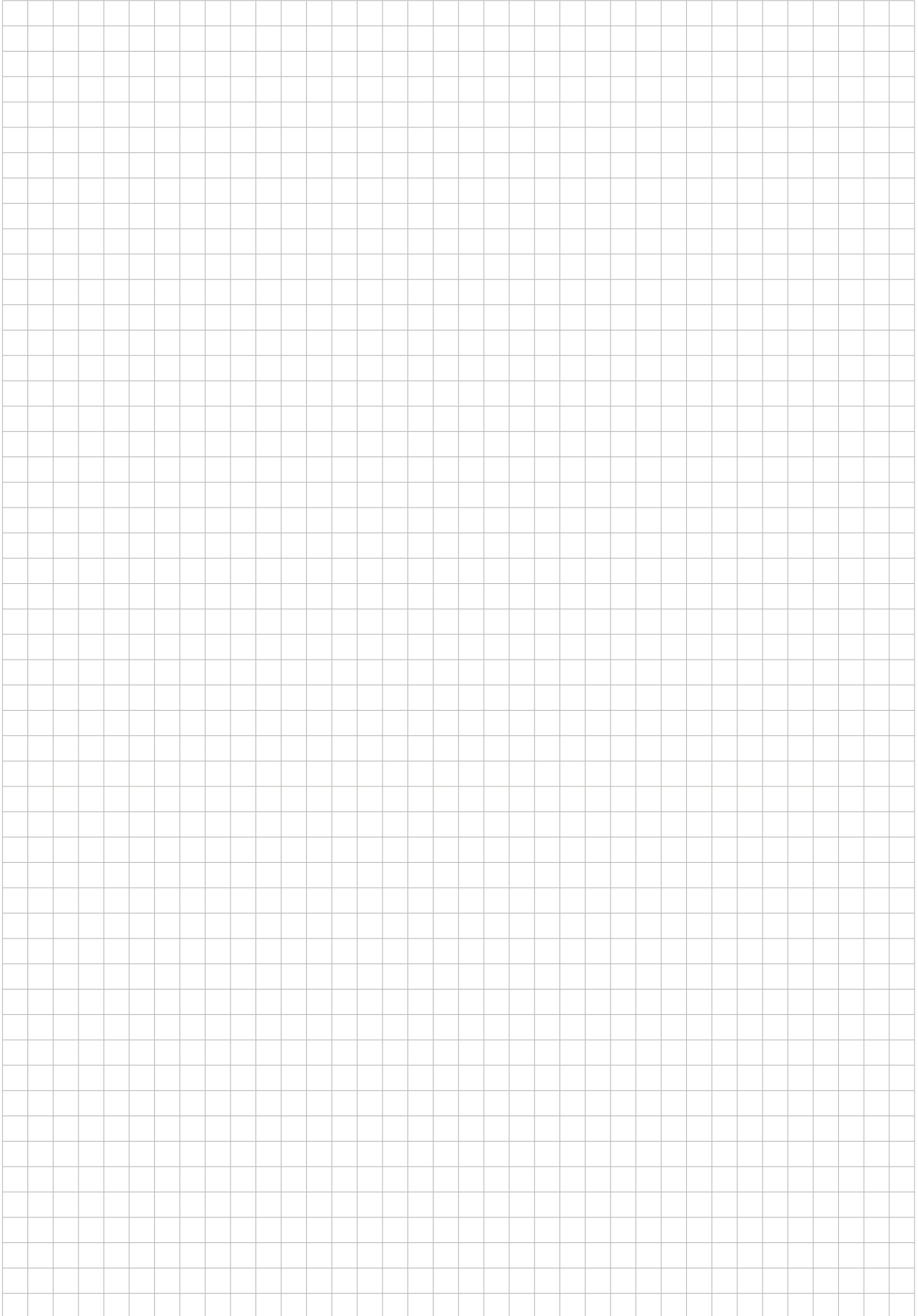



Global
Presence
Local
Commitment

 **PLASSON**[®]

PLASSON Ltd.

Maagan Michael

D.N. Menashe 37805 Israel

Tel: +972-4-6394711

Fax: +972-4-6390887

E-mail: sales@plasson.com

www.plasson.com